



BEARING KITS
TRANSFER CASE



United Motive Products Performance Motive Kits

Transfer Case

**Master, Deluxe, Basic, Sealant, Small Parts,
Pump Kits, OE Chain, Assemblies, and Sets.**

Industry Standard Catalog 1999/2000

*Product manufactured by Motive Kits establishes the
Industry Standard for Quality & Design Completeness in Medium
& Light Duty Transfer Case Overhaul Kits*

**SUV's, Jeeps, Vans, Medium & Light Truck, 4X4's of All
Type & Description.
On & Off Road—Stock & Modified.**

**Motive Kits are Marketed, Installed & Asked for Nationwide by
Guys whose Specialized Practice is Rebuilding
4 X 4 Vehicle Gear Cases to OE Specifications.
Specified Nationwide by Guys whose Specialty is the
Toughest most Demanding 4X4 Applications.**

*A Complete Line of Quality Overhaul Kits in Levels of Completeness
Popular in the Market—OE Design & Genuine Parts, or
Rebuilder Designed & Tested Lighter Duty Kits.*

Index, General Information & Catalog Use Guide

Please take a moment to read through this

Our Transfer Case Catalog has been created in a new and simplified format. We realize new catalogs, and especially catalogs with new formats, can be confusing. Follow this guide for ease in learning to use this catalog. It's really simple and informative once you learn how it is organized.

The Kit Catalog divides into Sections

Section I is the The Quick Reference Guide. It is organized by Vehicle Manufacturer with the Transfer Case Alphabetically listed by Model Number in the Tabs. This guide quickly identifies the most Popular Major Bearing Overhaul and Sealant Kits available from stock. The Tabs also display the kit's Component Parts Drawing page number in the Bold Black Box

NP 207 Universal Designed Kit Dodge, GM & Jeep	48			
100% NPG Product Shift Fork Insert Sets Included		SK 207	TC 207	TCM 207

The Light Lined Box Contains Our TC Series, Heavy Duty, Kits built to OEM Specification for the Application

<i>Lighter Duty or Aftermarket Automotive Design</i>	K1 00907	BK 207
--	----------	--------

The Black Box Lists Our BK and K Series, Automotive, Aftermarket Designed Overhaul Kits for the Application.

Example from Section I-NP/207

Section II

Is formatted into Sub-Sections by Case Manufacturer:

II-BW	Borg Warner
II-D	Dana
II-NP	New Process
II-R	Rockwell

(Please See Page 18 for the complete Reference Guide)

Each Manufacturer's Sub Section begins with a Index organized by the Kit's Root Number. The Root Number is the same as the Transfer case's Model Number for U.S. Made Units. This index cross references the Component Parts Drawing, and also serves as a Major Kit Popularity Guide. All kits marked with the symbol ● are recommended for a Rebuilder or Distributor Customers to Stock.

13-56 Part Time Ford, Bronco & Truck 1986 & After Electric or Manual	24
Parts Drawing See Page ▲	
<ul style="list-style-type: none"> ● Master Overhaul Kit ● Deluxe Bearing & Sealant 	TCM 1356-XJ TC 1356-XJ

Example from Section II-BW/1356.a

The Black Box directs the user to the page for the Kit Component Drawing.

Section II The Kit Component Drawing

Specific Application Information is listed in the Header box.
Popular Major Kit Formats follow in the Header Kit Part Number Box(es)
The symbol ▼ is the Column Indicator.

Dana Model 28 Ford 1989 & After				
TC 28-F XJ				▼
TC 28-F				▼
BK 28				▼
<i>Major Bearing Group</i>				
Input Ball Brg	F09Z-7065A		◆	◆
Input Ball Brg	209		◆	◆
Frnt O/P Shf Frt	108		◆	◆

Example from Section II-D28.d

Product Groups are separated by Group Boxes, as in the *Major Bearing Group* example above. The symbol ◆ is the Part Included Marker. Reading vertically down the column yields the kit content list. A horizontal comparison of rows highlights the content difference between kit formats. The differences may be in the completeness level, or due to a light duty part or parts substitution or to an aftermarket change. An example of the latter is the 209 ball bearing replacement for Ford Part Number F09Z-7065A in the example above.

O-Ring	AS029	◆	◆	◆	◆
SK 28-F		▲			

Example from Section II-D28.d Continued

The Lower Title Box Lists the Standard Sealant Kits. Sealant Kits are displayed in a unique column
The Column Indicator used with the a Lower Title Box is the symbol ▲

Section II The Recap Sheet

A Recap Sheet follows each Group of Manufacturer's Component Drawings. It is simply a listing of all of our Major and Minor Kits listed by our number.
Use this to located a kit's Drawing Page from a production kit number.

Section III is divided into three Sub-Sections

Section III.a A Listing by Transfer Case Manufacturer and Model Number
for Standard Production Sealant, Small Parts, and Miscellaneous Kits,
Assemblies or Sets.

Section III.b Popular Transfer Case Adapter Gaskets
Identification Sheet
Standard Package Quantity

Section III.c A Comprehensive Competitive Kit Interchange



Transfer Case Overhaul Kit General Index

Section I	Kit Guide by Vehicle Manufacturer, Model, Engine Type et al	1
	Chrysler/Dodge Applications	2
	Chrysler/Jeep Applications	4
	Ford Applications	6
	GM Applications	10
	International/Navistar	14
	Japanese Vehicles	16
Section II	Kit Component Parts Drawings	18
<i>Sect 11-BW</i>	Borg Warner	19
	B-W Overhaul Kit Dwg Index	20
	B-W Overhaul Kit Drawings	22
	B-W Overhaul Kit Recap	29
<i>Sect 11-D</i>	Dana	30
	Dana Overhaul Kit Dwg Index	31
	Dana Overhaul Kit Drawings	32
	Dana Overhaul Kit Recap	37
<i>Sect 11-NP</i>	New Process/New Venture	38
	NP Overhaul Kit Dwg Index	39
	NP Overhaul Kit Drawings	41
	NP Overhaul Kit Recap	53
<i>Sect 11-R</i>	Rockwell	54
	Rockwell Kit Drawings	55
	Rockwell Kit Recap	57
Section III	Sealant Kit, Small Parts Kits Gaskets & Interchanges	58
<i>Sect III-a</i>	Sealant, Small Parts Kit, Sets & Assemblies	59
<i>Sect III-abw</i>	Borg Warner	59
<i>Sect III-ad</i>	Dana	61
<i>Sect III-anp</i>	New Process/New Venture	62
<i>Sect III-b</i>	Adapter Gaskets	64
<i>Sect III-c</i>	Kit Interchange for Competitive Kit Numbers	66



Section I

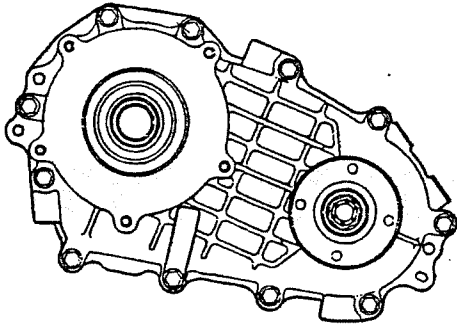

Transfer Case Kit Application Guide



Chrysler Dodge Transfer Case Master, Bearing & Sealant Kits Quick Reference Guide

	Dwg. Page	Order Sealant Kit	Order Bearing & Sealant Kit	Order Master Overhaul Kit
NP 200 & 201 1968 & Before 100% NPG Product	41	SK200	TC200	
Dodge NP 203 1973-1979 Dodge Heavy Duty Applications 100% NPG Product	43	SK203-G	TC203-G	TCM 203-G
<i>Lighter Duty or Aftermarket Automotive Design</i>		K100900	BK203G	
NP 203 Universal Dodge, and Popular GM & Ford 100% NPG Product	42	SK203-U	TC203-U	TCM203-U
<i>Lighter Duty or Aftermarket Automotive Design</i>		K100900U	BK203	
NP 205 Direct Mount 1988 & After Dodge Heavy Duty Truck with Getrag 360 Trans & Cummins Engine. 100% NPG Product	44	SK205-D	TC205-D	TCM 205-D
<i>Lighter Duty or Aftermarket Automotive Design</i>			BK205-D	
NP 205 Direct Mount 1987/8 & Before Automatic Dodge Truck & X 4 Vehicles 100% NPG Product	45	SK205-GDM	TC205-GDM	TCM205-GDM
<i>Lighter Duty or Aftermarket Automotive Design</i>		K100901		
NP 205 Universal Direct Mount 1987 & Before Universal Except Early GM with 400 Automatic & Chrysler/Dodge with Cummins Engine 100% NPG Product	44	SK205-UDM	TC205-UDM	TCM 205-UDM
NP 205 Remote Mount Only Universal also Early GM and Ford Midship Applications 100% NPG Product	46	SK205-DFG	TC205-DFG	TCM205-DFG





Chrysler Dodge Transfer Case Master, Bearing & Sealant Kits Quick Reference Guide

	Dwg Page	Order Sealant Kit	Order Bearing & Sealant Kit	Order Master Overhaul Kit.
NP 207 Universal	48			
Also fits GM & Jeep 100% NPG Product. Shift Fork Insert Set Included		SK207	TC207	TCM207
<i>Lighter Duty or Aftermarket Automotive Design</i>		K100907	BK207	
NP 208 Universal	47			
Also fits Ford GM & Jeep 100% NPG Product. Shift Fork Insert Set Included		SK208-XJ SK208	TC208-XJ	TCM208
<i>Lighter Duty or Aftermarket Automotive Design</i>		K100908	BK208	
NP 231 Universal 1995 & Before	48			
Double Row Ball Brg Input & C/S Welsh Plug 100% NPG Product. Shift Fork Insert Set Included		SK207	TC231	TCM231
<i>Lighter Duty or Aftermarket Automotive Design</i>		K100907	BK231	
NP 231, 233 Dodge	49			
Single Row Ball Brg Input 100% NPG Product. Shift Fork Insert Set Included		SK207	TC233	TCM233
<i>Lighter Duty or Aftermarket Automotive Design</i>		K100907		
NP 241 Dodge	50			
Single or Double Row Ball Brg Input 100% NPG Product. Shift Fork Insert Set Included		SK241	TC241-U	
Single Row Ball Brg Input 1993 & After 100% NPG Product. Shift Fork Insert Set Included		SK241-AXJ	TC241-A	
<i>Lighter Duty or Aftermarket Automotive Design</i>		K100908A	BK241-A	
Double Row Ball Brg Input 1993 & Before 100% NPG Product. Shift Fork Insert Set Included		SK241	TC241	
<i>Lighter Duty or Aftermarket Automotive Design</i>		K100908A	BK241	
NP 241 Dodge Diesel 1994 & After	50			
Single Row Ball Brg Input & Single Sprocket Brg 100% NPG Product. Shift Fork Insert Set Included		SK241-AXJ	TC241-DHD	



Chrysler Jeep Transfer Case Master, Bearing & Sealant Kits Quick Reference Guide

	Dwg Page	Order Sealant Kit	Order Bearing & Sealant Kit	Order Master Overhaul Kit
BW 13-05 Quadratrac 1973-80	22			
Use TC1305 for Zero Reduction Units Use TC1305-B For Retrofit Units		SK1305	TC1305-XJ TC1305 TC1305-B	
Dana Model 18 1961 & After	32			
Also Fits IHC/Navistar 100% Dana Product		SK18	TC18	TCM18
<i>Lighter Duty or Aftermarket Automotive Design</i>		K100914	BK18	
Dana Model 20 1966-77	32			
Also Fits IHC/Navistar 100% Dana Product		SK20	TC20	TCM20
<i>Lighter Duty or Aftermarket Automotive Design</i>		K100915	BK20	
Dana Model 300 1975-83	35			
TCM300-XJ Includes 25877 & 25880 Tpr Cones Includes Small Parts Kit and Shaft 942215 100% Dana Product		SK300		TCM300-XJ
100% Dana Product. Shift Fork Insert Set Included		SK300	TC300	TCM300
<i>Lighter Duty or Aftermarket Automotive Design</i>		K100916	BK300	
NP 207 Universal	48			
Also fits GM & Dodge 100% NPG Product. Shift Fork Insert Set Included		SK207	TC207	TCM207
<i>Lighter Duty or Aftermarket Automotive Design</i>		K100907	BK207	
NP 208 Universal	47			
Also fits Ford GM & Dodge 100% NPG Product. Shift Fork Insert Set Included		SK208-XJ SK208	TC208-XJ	TCM208
<i>Lighter Duty or Aftermarket Automotive Design</i>		K100908	BK208	



Chrysler Jeep Transfer Case Master, Bearing & Sealant Kits Quick Reference Guide

	Dwg Page	Order Sealant Kit	Order Bearing & Sealant Kit	Order Master Overhaul Kit
NP 229, 228, 219, 218, 129, 128, 119, & 118 1980 & After With & W/O Viscous Coupler 100% NPG Product. Shift Fork Insert Set Included <i>Lighter Duty or Aftermarket Automotive Design</i>	47	SK228/9 SK228/9-X	TC228/9	TCM228/9
		K100906	BK228/9X	
NP 231 1987-92 Double Row Ball Brg Input & C/S Welsh Plug 100% NPG Product. Shift Fork Insert Set Included <i>Lighter Duty or Aftermarket Automotive Design</i>	48	SK207	TC231	TCM231
		K100907		
NP 242 Universal 100% NPG Product Shift Fork Insert Set Included <i>Lighter Duty or Aftermarket Automotive Design</i>	51	SK242	TC242	
		K100918	BK242	
NP 249 1992 & After Double Row Ball Brg Input Tag 52097529, 52097530, 52098667 & 53098682 100% NPG Product. Shift Fork Insert Set Included	52	SK249	TC249	
NP 249 1994 & After Single Row Ball Brg Input Tag 52097529, 52097530, 52098667 & 53098682 100% NPG Product. Shift Fork Insert Set Included	53	SK249	TC249-JA	





Ford Transfer Case Master, Bearing & Sealant Kits Quick Reference Guide

	Dwg Page	Order Sealant Kit	Order Bearing & Sealant Kit:	Order Master Overhaul Kit:
BW 13-45 Part Time Bronco & Truck 1981-86 100% Borg Warner Product Shift Fork Insert Set Included <i>Lighter Duty or Aftermarket Automotive Design</i>	22	SK1345-XJ SK1345	TC1345-XJ TC1345	TCM 1345-XJ
		K100909	BK1345	
BW 13-50 Part Time Electric & Man. Bronco II & Ranger 1983 & After 100% Borg Warner Product Shift Fork Insert Set Included <i>Lighter Duty or Aftermarket Automotive Design</i>	23	SK1350	TC1350	
		K100910	BK1350-X	
BW 13-54 Part Time Electric & Man. Case E8TZ-7050B 100% Borg Warner Product Shift Fork Insert Set Included <i>Lighter Duty or Aftermarket Automotive Design</i>	23	SK1350	TC1350	
		K100910	BK1350-X	
BW 13-54 Part Time Electric & Man. Case F0TZ-7050B 100% Borg Warner Product Shift Fork Insert Set Included <i>Lighter Duty or Aftermarket Automotive Design</i>	23	SK1354	TC1354	
		K100912	BK1354	
BW 13-56 Part Time Electric or Man. Bronco & Truck 100% Borg Warner Product Shift Fork Insert Set Included	24	SK1356-XJ	TC1356-XJ	TCM 1356-XJ
BW 13-56 Part Time Manual Only Bronco & Truck 100% Borg Warner Product Shift Fork Insert Set Included <i>Lighter Duty or Aftermarket Automotive Design</i>	24	SK1356	TC1356	TCM 1356
		K100919	BK1356	



Ford Transfer Case Master, Bearing & Sealant Kits Quick Reference Guide

	Dwg Page	Order Sealant Kit	Order Bearing & Sealant Kit	Order Master Overhaul Kit
BW 13-59 Bronco II & Ranger 4 X 2 1986-89	25			
100% Borg Warner Product & Design		1359-55-SS	TC1359	
<i>Lighter-Duty or Aftermarket Automotive Design</i>			BK1359	
BW 44-04 1995 & After	26			
Lube Washer Set Included 100% Borg Warner Product		SK4404	TC4404	
<i>Lighter-Duty or Aftermarket Automotive Design</i>			BK4404	
BW 44-05 Ford Explorer 1995 & After Electric or Manual	26			
100% Borg Warner Product Lube Washer Set & SF Insert Set Included		SK4405	TC4405	TCM4405
<i>Lighter-Duty or Aftermarket Automotive Design</i>			BK4405	
BW 44-06 Bronco & Expedition with Torque on Demand Electric or Manual	27			
Model No's 4405-000-012, 4405-000-017, 4405-000-020, and 4405-000-023 100% Borg Warner Product		SK4406-TOD	TC4406-TOD	TCM4406-TOD
BW 44-06 Full Size Truck without Torque on Demand Electric or Manual	27			
Model No's 4405-000-010, -011, -013, -014, -015 -016, -018, -019, -020, -021, -022 & -024 100% Borg Warner Product		SK4406-WO	TC4406-WO	TCM4406-WO
BW 44-07 Ford F250 & F350 Truck	28			
100% Borg Warner Product		SK4407	TC4407	
Dana Model 20 Ford Universal 1966-77	33			
100% Dana/Ford Product		SK20-F	TC20-FXJ	TCM20-FXJ



Ford Transfer Case Master, Bearing & Sealant Kits Quick Reference Guide

	Dwg Page	Order Sealant Kit	Order Bearing & Sealant Kit	Order Master- Overhaul Kit
Dana Model 20 Ford Late Only 1973-77 Only 100% Dana/Ford Product	33	SK20-F	TC20-FB	TCM20-FB
Dana Model 20 Ford Early Only 1966-72 Only 100% Dana/Ford Product	33	SK20-F	TC20-F	TCM20-F
Dana Model 21 1965-74 Heavy Duty Design 100% Dana/Ford Product	34	SK21-F	TC21-FHD	
<i>Lighter Duty or Aftermarket Automotive Design</i>			BK21	
Dana Model 24 1962-74 100% Dana/Ford Product	35	SK24	TC24	
<i>Lighter Duty or Aftermarket Automotive Design</i>			BK24	
Dana Model 28 1989 & After Suffix FXJ Kit Includes Viscous Coupler Brg 100% Dana/Ford Product	35	SK28-F	TC28-F T28-FXJ	
<i>Lighter Duty or Aftermarket Automotive Design</i>			BK28	
NP 203 Popular Ford Only Heavy Duty 50 mm bore Input 100% NPG Product	43	SK203-F	TC203-F	TCM203-F
<i>Lighter Duty or Aftermarket Automotive Design</i>		K100900F	BK203F	
NP 203 Ford F250, 3/4 Ton Truck 1974-76 Only Heavy Duty 50 mm bore Input 100% NPG Product	43	SK203-FX	TC203-FX	



Ford Transfer Case Master, Bearing & Sealant Kits Quick Reference Guide

	Dwg Page	Order Sealant Kit	Order Bearing & Sealant Kit	Order Master Overhaul Kit
NP 203 Universal Ford, GM or Dodge 100% NPG Product <i>Lighter Duty or Aftermarket Automotive Design</i>	42			
		SK203-U	TC203-U	TCM203-U
		K100900U	BK203	
NP 205 Direct Mount Ford Only 100% NPG Product <i>Lighter Duty or Aftermarket Automotive Design</i>	45			
		SK205-FDM	TC205-FDM	TCM205-FDM
		K100957	BK205-FDM	
NP 205 Direct Mount Universal Also Fits GM & Dodge 100% NPG Product	44			
		SK205-UDM	TC205-UDM	TCM205-UDM
NP 205 Midship Remote Mount Ford Only 100% NPG Product Shift Fork Insert Sets Included <i>Lighter Duty or Aftermarket Automotive Design</i>	46			
		SK205	TC205	TCM205
		K100947	BK205	
NP 208 Universal Also Fits GM, Dodge & Jeep Applications 100% NPG Product Shift Fork Insert Sets Included <i>Lighter Duty or Aftermarket Automotive Design</i>	47			
		SK208-XJ	TC208-XJ	TCM208-XJ
		K100908	BK208	



GM Transfer Case Master, Bearing & Sealant Kits Quick Reference Guide

	Dwg. Page	Order Sealant Kit	Order Bearing & Sealant Kit	Order Master Overhaul Kit
BW 13-70 Part Time Electric or Man. Truck & SUV 1988 & After	24			
100% Borg Warner Product Shift Fork Insert Set Included		SK1356-XJ	TC1356-XJ	TCM1356-XJ
BW 13-70 Part Time Manual Only Truck & SUV 1988 & After	24			
100% Borg Warner Product Shift Fork Insert Set Included		SK1356	TC1356	TCM1356
<i>Lighter Duty or Aftermarket Automotive Design</i>		K100919	TC1356-XH	TC1356-XHM
BW 13-72 Astro, Bravada, Safari 1988 & After	25			
100% Borg Warner Product & Design		SK1372	TC1372-XJ	
<i>Lighter Duty or Aftermarket Automotive Design</i>		K100959	BK1372	
BW 44-01 Ext Housing No. 1563167	26			
100% Borg Warner Product & Design		SK4401	TC4401	
NP 203 GM 1973-79	43			
Heavy Duty Design 100% NP Product		SK203-G	TC203-G	TCM203-G
<i>Lighter Duty or Aftermarket Automotive Design</i>		K100900	BK203G	
NP 203 Universal 1973-79	43			
Also Fits GM & Dodge Heavy Duty Design 100% NP Product		SK203-U	TC203-U	TCM203-U
<i>Lighter Duty or Aftermarket Automotive Design</i>		K100900	BK203G	
NP 203 GM Early 1972-73 with Cast Iron Tailhousing	43			
<i>Lighter Duty Automotive Design Only</i>		SK203-GX	BK203GX	BK203GXM

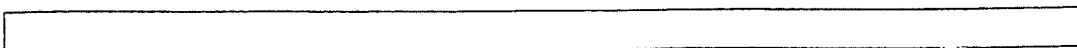



GM Transfer Case Master, Bearing & Sealant Kits Quick Reference Guide

	Dwg Page	Order Sealant Kit	Order Bearing & Sealant Kit	Order Master Overhaul Kit
NP 205 GM Direct Mount with 350 Auto	45			
100% NP Product		SK205-GDM	TC205-GDM	TCM205-GDM
<i>Lighter Duty or Aftermarket Automotive Design</i>		K100901		
NP 205 Universal Direct Mount with 350 Auto	44			
Also Fits Ford, Dodge & Int/Navistar 100% NP Product		SK205-UDM	TC205-UDM	TCM205-UDM
NP 205 GM Direct Mount with 400 Auto Only	45			
100% NP Product		SK205-4GDM	TC205-4GDM	TCM205-4GDM
<i>Lighter Duty or Aftermarket Automotive Design</i>			BK205-4GDM	
NP 207 Universal	48			
Also Fits Dodge & Jeep 100% NPG Product. Shift Fork Insert Sets Included		SK207	TC207	TCM207
<i>Lighter Duty or Aftermarket Automotive Design</i>		K100907	BK207	
NP 208 Universal	47			
Also Fits Ford, Dodge & Jeep Applications 100% NPG Product Shift Fork Insert Sets Included		SK208-XJ	TC208-XJ	TCM208-XJ
<i>Lighter Duty or Aftermarket Automotive Design</i>		K100908	BK208	



GM Transfer Case Master, Bearing & Sealant Kits Quick Reference Guide

	Dwg. Page	Order Sealant Kit	Order Bearing & Sealant Kit	Order Master-Overhaul Kit
NP 231C Double Row Ball Brg Input & C/S Welsh Plug Also Fits Ford, Dodge & Jeep Applications 100% NPG Product Shift Fork Insert Sets Included <i>Lighter Duty or Aftermarket Automotive Design</i>	48	SK231	TC231	TCM 231
		K100907	BK231	
NP 231 Double Row Ball Brg Input Also Fits Jeep Applications 100% NPG Product Shift Fork Insert Sets Included <i>Lighter Duty or Aftermarket Automotive Design</i>	49	SK231	TC231-HD	TCM 231-HD
		K100907		
NP 231, 233 Single or Double Row Ball Brg Input Also Fits Jeep Applications 100% NPG Product Shift Fork Insert Sets Included <i>Lighter Duty or Aftermarket Automotive Design</i>	49	SK231	TC231/3-HD	TCM 231/3-HD
		K100907		
NP 231, 233 Single Row Ball Brg Input Also Fits Jeep Applications 100% NPG Product Shift Fork Insert Sets Included <i>Lighter Duty or Aftermarket Automotive Design</i>	49	SK231	TC233	TCM 233
		K100907		
NP 241 1993 & Before Double Row Ball Brg Input Also Fits Jeep Applications 100% NPG Product Shift Fork Insert Sets Included <i>Lighter Duty or Aftermarket Automotive Design</i>	50	SK241	TC241	
		K100908A	BK241	

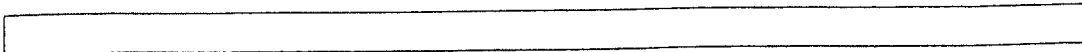



GM Transfer Case Master, Bearing & Sealant Kits Quick Reference Guide

	Dwg Page	Order Sealant Kit	Order Bearing & Sealant Kit.	Order Master- Overhaul Kit.
NP 241 Universal Single or Double Row Ball Brg Input	50			
Also Fits Jeep Applications 100% NPG Product Shift Fork Insert Sets Included		SK241	TC241-U	
New Venture 243 1995 & After	51			
100% NPG Product Shift Fork Insert Sets Included		SK243	TC243	
Rockwell 221	55			
100% Rockwell Product. Complete 479 Installation Kit Included		SK221	TC221-GXJ	

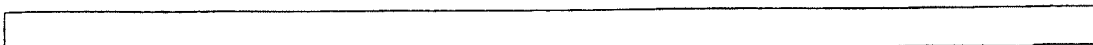



International/Navistar Transfer Case Master, Bearing & Sealant Kits Quick Reference Guide

	Dwg Page	Order Sealant Kit	Order Bearing & Sealant Kit	Order Master Overhaul Kit
IHC TC141 1950-79	41			
NP202		SK200		
<i>Lighter Duty or Aftermarket Automotive Design</i>		SK200	BK202-NP	
IHC TC142 1971-76	45			
NP 205 100% NP Product		SK205-GDM	TC205-GDM	TCM 205-GDM
<i>Lighter Duty or Aftermarket Automotive Design</i>		K100901		
IHC TC144 1961-68	32			
Dana Model 18 100% Dana Product		SK18	TC18	TCM 18
<i>Lighter Duty or Aftermarket Automotive Design</i>		K100914	BK18	
IHC TC145 1961-80	20			
Dana Model 20 100% Dana Product		SK20	TC20	TCM 20
<i>Lighter Duty or Aftermarket Automotive Design</i>		K100915	BK20	
IHC TC146 1971-80	35			
Dana Model 300 TCM300-XJ Includes 25877 & 25880 Tpr Cones Includes Small Parts Kit and Shaft 942215 100% Dana Product		SK300		TCM300-XJ
Shift Fork Insert Set Included. 100% Dana Product		SK300	TC300	TCM 300
<i>Lighter Duty or Aftermarket Automotive Design</i>		K100916	BK300	
IHC TC155	55			
Rockwell 223H Taper Roller Brg Design Bearing & Oil Seal Kit			TC223-H	
<i>Lighter Duty Design</i>			TC167	
IHC TC156	55			
Rockwell 223C Taper & Ball Brg Design Bearing & Oil Seal Kit			TC223-C	
<i>Lighter Duty or Aftermarket Automotive Design</i>				



International/Navistar Transfer Case Master, Bearing & Sealant Kits Quick Reference Guide

	Dwg Page	Order Sealant Kit	Order Bearing & Sealant Kit	Order Master Overhaul Kit
IHC TC164, and TC168 Rockwell 226-31 Bearing & Oil Seal Kit	56		TC226-31	
IHC TC170 Rockwell 226L Bearing & Oil Seal Kit	56		TC226-L	
IHC TC173 DANA 787, 792 Bearings Only Kit	36		TC420483-X	
IHC TC175 DANA 784 Bearings Only Kit	36		TC420482-X	
IHC TC176 DANA 787, 792 Bearings Only Kit	36		TC420483-X	
IHC TC177 DANA 738A Bearings Only Kit	36		TC420412-X	



Japanese Vehicle Transfer Case Bearing & Sealant Kits Quick Reference Guide

	Dwg. Page	Order Sealant Kit	Order Bearing & Sealant Kit	Order Master Overhaul Kit
Isuzu 1988 & After Isuzu 4 X 4 Truck & SUV with 4L30E Automatic			BK425	
Mazda 4 X 4 Truck 1986 & After			BK368	
Mazda MPV Van s4 X 4 1991 & After			BK384	
Mitsubishi KM100, Truck 1980 & After Used with D50 Series Transmission			BK181	
Mitsubishi KM120 Montero 1991 & After			BK181A	
Nissan Model T100L Truck 1980, & After			BK206-XJ BK206	
Nissan Model TX10 10/91 & After			BK260	
Nissan Axxess 4 X 4 1989 & After			BK173B	
Suzuki TS45 Remote Mount Samurai 4 X 4 1985-90			BK236	
Suzuki 4 X 4 Sidekick 1987 & After			BK236A	





Japanese Vehicle Transfer Case Bearing & Sealant Kits Quick Reference Guide

	Dwg Page	Order Sealant Kit	Order Bearing & Sealant Kit	Order Master Overhaul Kit
Toyota W100 Truck 1978 & After Gear to Gear Drive Bearing & Sealant Kit			BK195	
Toyota R100 Truck 1986 & After Chain Driven Bearing & Sealant Kit			BK195A	
Toyota Landcruiser 1969-75 with 3 Speed Transmission			BK263	
Toyota Landcruiser 1973- July 1980 with 4 Speed Transmission			BK275	
Toyota Landcruiser Aug 1980 through 1987 with 4 Speed Transmission			BK258	
Toyota Landcruiser Aug 1980 through 1987 with 5 Speed Transmission			BK258A	
Toyota Landcruiser Aug 1990 & After with 5 Speed Transmission			BK422	

Section II

Major Kit Component Parts

	Page
Borg-Warner	19-29
Page Number Guide	20-21
Kit Drawings	22-28
Recap Sheet/Guide	29

	Page
Dana	30-37
Page Number Guide	31
Kit Drawings	32-36
Recap Sheet/Guide	37

	Page
New Process	38-53
Page Number Guide	39-40
Kit Drawings	41-52
Recap Sheet/Guide	53

	Page
Rockwell	54-57
Kit Drawings	55-56
Recap Sheet/Guide	57

Borg Warner

Ford & GM

Major Kit Drawings-Parts List Guide Page 20-21

All Kits and Assemblies-Recap Sheet Page 29



Borg Warner Transfer Case Kit Drawing Page Number Index

● Major Kit Recommended Stock for a Rebuilder/Distributor

13-05 Jeep Quadratrac 1973-80	22
Parts Drawing See Page ▲	
<i>Deluxe Bearing & Sealant</i>	TC 1305-XJ
<i>Bearing & Sealant -Original</i>	TC 1305

13-45 Part Time Ford, Bronco & Truck 1981-86	22
Parts Drawing See Page ▲	
<i>Master Overhaul Kit</i>	TCM 1345-XJ
<i>Deluxe Bearing & Sealant</i>	TC 1345-XJ
<i>Bearing & Sealant -Original</i>	TC 1345
<i>Basic Bearing & Sealant</i>	BK 1345

13-50 Part Time Ford, Bronco II & Ranger 1981-86 Electric or Manual	23
Parts Drawing See Page ▲	
● <i>Deluxe Bearing & Sealant</i>	TC 1350
<i>Basic Bearing & Sealant</i>	BK 1350-X

13-54 Part Time Ford, Bronco II & Ranger 1983-92 Electric or Manual Case No. E8TZ7050B	23
Parts Drawing See Page ▲	
● <i>Deluxe Bearing & Sealant</i>	TC 1350
<i>Basic Bearing & Sealant</i>	BK 1350-X

13-54 Part Time Ford, Bronco II, Ranger 1993 & After Electric or Manual Case No. F0TZ7050B	23
Parts Drawing See Page ▲	
<i>Deluxe Bearing & Sealant</i>	TC 1354
<i>Basic Bearing & Sealant</i>	BK 1354

13-56 Part Time Ford, Bronco & Truck 1986 & After Electric or Manual	24
Parts Drawing See Page ▲	
● <i>Master Overhaul Kit</i>	TCM 1356-XJ
● <i>Deluxe Bearing & Sealant</i>	TC 1356-XJ

13-56 Part Time Ford, Bronco & Truck 1986 & After Manual Only	24
Parts Drawing See Page ▲	
<i>Master Overhaul Kit</i>	TCM 1356
<i>Deluxe Bearing & Sealant</i>	TC 1356
● <i>Basic Bearing & Sealant</i>	BK 1356

13-59 Ford, Bronco II & Ranger 4 X 2 1987-89	25
Parts Drawing See Page ▲	
<i>Deluxe Bearing & Sealant</i>	TC 1359
<i>Basic Bearing & Sealant</i>	BK 1359

13-70 Part Time GM SUV & Truck 1986 & After Electric or Manual	24
Parts Drawing See Page ▲	
● <i>Master Overhaul Kit</i>	TCM 1356-XJ
● <i>Deluxe Bearing & Sealant</i>	TC 1356-XJ

13-70 Part Time GM SUV & Truck 1986 & After Manual Only	24
Parts Drawing See Page ▲	
<i>Master Overhaul Kit</i>	TCM 1356
<i>Deluxe Bearing & Sealant</i>	TC 1356
● <i>Basic Bearing & Sealant</i>	BK 1356

13-72 GM Astro, Bravada, or Safari 1988 & After	25
Parts Drawing See Page ▲	
<i>Deluxe Bearing & Sealant</i>	TC 1372-XJ
<i>Basic Bearing & Sealant</i>	BK 1372

44-01 GM 1988 & After w/Extension Housing No. 15 63 16 7	26
Parts Drawing See Page ▲	
<i>Deluxe Bearing & Sealant</i>	TC 4401

44-04 Ford 1995 & After	26
Parts Drawing See Page ▲	
<i>Deluxe Bearing & Sealant</i>	TC 4404



Borg Warner Transfer Case Page Number Index for Kit Drawings

- Major Kit Recommended Stock for a Rebuilder/Distributor

44-05 Ford Explorer, Electric or Manual 1995 & After	26
Parts Drawing See Page ▲	
<i>Master Overhaul Kit</i>	TCM 4405
<i>Deluxe Bearing & Sealant</i>	TC 4405
<i>Basic Bearing & Sealant</i>	BK 4405

44-06 Ford Bronco & Expedition Electric or Manual with Torque on Demand 1995 & After	27
Parts Drawing See Page ▲	
<i>Master Overhaul Kit</i>	TCM 4406-TOD
<i>Deluxe Bearing & Sealant</i>	TC 4406-TOD

44-06 Ford F150 Truck. Electric or Manual without Torque on Demand 1995 & After	27
Parts Drawing See Page ▲	
<i>Master Overhaul Kit</i>	TCM 4406-WO
<i>Deluxe Bearing & Sealant</i>	TC 4406-WO

44-07 Ford F250, 350 Truck 1995 & After	28
Parts Drawing See Page ▲	
<i>Deluxe Bearing & Sealant</i>	TC 4407

44-70 GM 1989 & After	28
Parts Drawing See Page ▲	
<i>Deluxe Bearing & Sealant</i>	TC 4470
<i>Basic Bearing Kit</i>	BK 4407

44-72 GM 1988 & After	25
Parts Drawing See Page ▲	
<i>Deluxe Bearing & Sealant</i>	TC 1372-XJ
<i>Basic Bearing & Sealant</i>	BK 1372



Borg-Warner Master, Bearing and other Kit Content Drawings

Borg Warner 13-05 Jeep Quadratrac 1973-80	
TC1305-XJ	
TC1305	
TC1305-B	
<i>Major Bearing Group</i>	
Input Ball Brg	206SF12
Frt O/P Shf Frt	B4416
Rr O/P Shf Rr	206SF12
Frt O/P Shf Rr	B3416
Frt Int Shaft	B3416
Rr Int Shaft	B3416
Thrust Ndl Brg Set	NTA2840-4
<i>Oil Seal Group</i>	
Input (2)	13568
Frt & Rr O/P (2)	15655
<i>Paper, Rubber, Small Parts Group</i>	
Sealant & Gasket Set	1305-55
Grommets & Rings	1305-RSK
SK 1305	

13-05 Chain OE Borg Warner	
3/8 P X 2-1/4 W X 96 Links	HV007
3/8 P X 2-1/4 W X 96 Links For Units with Zero Reduction	HV007X

Borg Warner 13-45 Ford 1981-86	
13-45 Chain OE Borg Warner	
1/2 P X 1-1/4 W X 84 Links	HV012
1/2 P X 1-1/2 W X 86 Links	HV013

Borg Warner 13-45 Sealant Kit	
SK 1345-XJ	
SK 1345	
K 100909	SK1345-X
Input Seal	710062
Frt & Rr O/P Seals (2)	18662
<i>Paper, Rubber, Small Parts Group</i>	
SF Insert Set	SFI-1345
Adapter Gasket	36086
Spline Wash (2)	1300016002
O-Ring	AS111
Ultra Black 598	22072

Borg Warner 13-45 Ford 1981-86	
TCM1345-XJ	
TC1345-XJ	
TC1345	
BK 1345	
<i>Major Bearing Group</i>	
Input Ball Brg	207
Input Ndl Brg	B2812
Input Bushing	1345-127-001
Frt O/P Shf Frt	207
Rr O/P Shf Rr	SCE2012
Frt O/P Shf Rr	1345-127-002
SF Insert Set	SFI-1345
Small Parts Kit	SP1345-50A
<i>Replacement Sealant Kit</i>	
Deluxe Kit	SK1345
Basic Kit	K100909

Borg Warner 13-45 Small Parts Kit	
SP 1345-50	
SP 1345-50A	
O-Ring	AS111
Ret. Rings (2)	1345-040-001
Pin, Range Fork	1345-043-001
Pin, Rail	1345-043-006
Shift Rail Clips (2)	1345-056-001
Lever Clip	1345-056-002
Range Fork Clip	1345-056-003
Ctn Cage Key	1345-104-001
Plast. Bushing	1345-127-003
Plast. Bushing	1345-127-004
Plast. Bushing	1345-127-005
Plantary Sn Ring	1345-139-001
Plate Snap Ring	1345-139-006
Spring	1345-156-001
Spring	1345-156-006
Thrust Washer	1345-193-001
Thrust Washer	1345-193-004
Thrust Washer	1345-193-005
SF Insert Set (4)	1345-235-001

Borg Warner 13-45 Pump Overhaul Kit	
Contains all Required Filter, Retainer, Pin Cover & Spring Parts	PK 1345

**Borg-Warner Master, Bearing
and other Kit Content Drawings**



Borg Warner 13-50 Ford B-W 13-54 Ford with Case E8TZ-7050B	
TC 1350	
BK 1350-X	
<i>Major Bearing Group</i>	
Input Ball Brg	109-L
Input Ndl Brg	BCE1816
Input Bushing	1345-127-001
Frnt O/P Shf Brg	206
Rr O/P Shf Brg	206
Ball Brg	108
Ndl Assy	JH1612
Frnt O/P Shf Rr	1345-127-002
<i>Sealant Group</i>	
Input	710662
Rr O/P	710663
Frnt O/P	15900
<i>Paper, Rubber, Small Parts Group</i>	
SF Insert Set (4)	1345-235-001
Adapter Gasket	G1350
Spline Wash (2)	1300016002
Ultra Black 598	22072
K1 0091 0	SK1350-X
SK 1350	

Borg Warner 13-54 Ford Case F0TZ-7050B	
TC 1354	
BK 1354	
<i>Major Bearing Group</i>	
Input Ball Brg	109-L
Input Ndl Brg	BCE1816
Frnt O/P Shf Brg	206-L
Rr O/P Shf Brg	206-L
Ball Brg	108
Ndl Assy	JH1612
Frnt O/P Shf Rr	1345-127-002
<i>Sealant Group</i>	
Input	710663
Frnt & Rr O/P (2)	710663
<i>Paper, Rubber, Small Parts Group</i>	
SF Insert Set (4)	1345-235-001
Adapter Gasket	G1350
O-Ring	AS111
Spline Wash (2)	1300016002
Ultra Black 598	22072
K1 0091 2	SK1354-X
SK 1354	

13-50, 13-54 Chain OE Borg Warner	
1/2 P X 1-1/4 W X 62 Links	HV022

Borg Warner 13-50 & 13-54 Pump Overhaul Kit	
Contains all Required Filter, Retainer, Pin Cover & Spring Parts	PK 1350

13-45, 13-50, 13-54 Shift Fork Insert Set	
4 Pcs 1345-235-001	SFI-1345

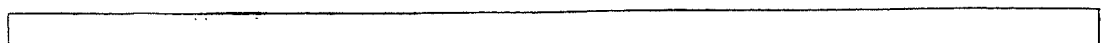



Borg-Warner Master, Bearing and other Kit Content Drawings

Borg Warner 13-56, 13-70 Ford or GM Electric & Manual	
TCM1356-XJ	
TC-1356-XJ	
<i>Major Bearing Group</i>	
Input Ball Brg	110
Frt Output Ball Brg	207
Rr Output Ball Brg	207
Case Half Bush	1356127000
Bushing	E0TZ-7120B
Frt O/P Shf Frt	BK3026
Frt O/P Shf Rr	SCE2012
<i>Oil Seal Group</i>	
Input Seal	1300-016-001
Frt O/P Seal	1900-044-012
Rr O/P Seal	1900-044-012
O/P Seal	1900-044-013
Elect Shift Shaft	1300-044-001
<i>Paper, Rubber, Small Parts Group</i>	
SF Insert Set	SFI-1356
Adapter Gasket	E7TZ-7086A
PTO Gasket	6067-X
Spline Wash (2)	1300-016-002
O-Ring	AS014
Ultra Black 598	22072
Small Parts Kit	SP1356-50A

Borg Warner 13-56, 13-70 Ford or GM Manual Only	
TCM1356	
TC1356	
BK 1356	
<i>Major Bearing Group</i>	
Input Ball Brg	110
Frt O/P Ball Brg	207
Rr Output Ball Brg	207
Case Half Bush	1356127000
Bushing	E0TZ-7120B
Frt O/P Shf Frt	BK3026
Frt O/P Shf Rr	SCE2012
SF Insert Set	SFI-1356
Small Parts Kit	SP1356-50A
<i>Replacement Sealant Kit</i>	
Deluxe Kit	SK1356
Basic Kit	K100919

13-56, 13-70 Sealant Kit	
SK1356-XJ	
SK1356	
K100919	SK1356-X
Input Seal	1300-016-001
Frt O/P Seal	1900-044-012
Rr O/P Seal	1900-044-012
O/P Seal	1900-044-013
Elect Shf Shft Seal	1300-044-001
Adapter Gasket	E7TZ-7086A
PTO Gasket	6067-X
Spline Wash (2)	1300-016-002
O-Ring	AS014
Ultra Black 598	22072

Borg Warner 13-56, 13-70 Small Parts Kit	
SP1356-50	
SP1356-50A	
O-Ring	AS014
Snap Ring	T8671/2
Spline Wash (2)	1300-016-002
Plugs (3)	1300-052-003
Vent Tube	1300-072-001
Snap Ring	1300-139-009
Snap Ring	1300-139-010
Snap Rings (2)	1300-139-027
Set Screw	1300-183-019
Clip Ring	1345-056-002
Snap Ring	1345-139-004
Washer	1345-139-005
Spring	1350-156-002
Speedo Gear Ret	1356-053-003
Assist Bushing	1356-127-008
Assist Spring	1356-156-002
SF Insert (2)	1345-235-001
SF Insert (2)	1356-235-001

13-56, 13-70 Chain OE Borg Warner	
13-56 Ford 1/2 PX 1-1/4 W X 84 Links	HV012
13-70 GM 1/2 PX 1-1/4 W X 72 Links	HV014
13-70 GM 1/2 PX 1-1/4 W X 72 Links	HV025

Borg Warner 13-56, 13-70 Pump Overhaul Kit	
Contains all Required Filter, Retainer, Pin Cover & Spring Parts	PK 1356

Borg-Warner Master, Bearing and other Kit Content Drawings



Borg Warner 13-59 Ford Bronco II, Ranger 1987 & After	
TC1359	
BK 1359:	
<i>Major Bearing Group</i>	
Input Ball Brg	E7TZ-7025B
Output Ball Brg	1300-130-003
Bushing	E0TZ-7065B
Frt O/P Shf Rr	1000-132-009
<i>Oil Seal Group</i>	
Input Seal	710062
Output Seal	710063
Ultra Black 598	22072
RTV	10250
SK 1359:	
K 100959	

Borg Warner 13-72, 44-72 GM SUV's 1988 & After	
TC1372-XJ	
BK 1372	
<i>Major Bearing Group</i>	
Input Ball Brg	109-L
Frt O/P Frt Brg	207-L
Frt O/P Rr Brg	JH1612
Rr O/P Frt Brg	1900-132-001
Rr O/P Rr Ball Brg	208-L
<i>Oil Seal Group</i>	
Input Seal	1000-044-054
O/P Seal	1300-044-013
O/P Seal	1900-044-012
O/P Seal	1900-044-013
O/P Seal	18662
<i>Paper, Rubber, Small Parts Group</i>	
Lube Washer	1900-193-005
Lube Washer	1900-193-006
Bushing	1900-127-003
Bushing	1900-127-004
Adapter Gasket	33706
Spline Wash	1300-016-002
O-Ring	AS014
Ultra Black 598	22072
SK 1372-XJ	
K 100972	

13-72, 44-72 Chain: OE Borg Warner	
3/8 P X 1-3/4 W X 86 Links Straight Pitch Chain	HV032
3/8 P X 1-3/4 W X 86 Links Random Pitch Chain	HV033

Borg Warner 13-72, 44-72 Small Parts Kit	
SP 1372-50	
SP 1372-50A	
O-Ring	AS014
Spline Wash	1300-016-002
Spacer	1372-053-002
Oil Flinger	1900-034-002
Ret Ring	1900-139-001
Ret Ring	1900-139-003
Ret Ring	1900-139-007
Lube Washer	1900-193-005
Lube Washer	1900-193-006

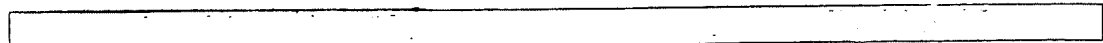



Borg-Warner Master, Bearing and other Kit Content Drawings

Borg Warner 44-01 GM Ext Housing 1563167	
TC 4401	
<i>Major Bearing Group</i>	
Input Ball Brg	110
Frt O/P Ball Brg	207
Rr O/P Ball Brg	207
Frt O/P Shf Rr	SCE2012
Case Half Bush	1356-127-000
<i>Oil Seal Group</i>	
Input Seal	1300-016-001
Frt O/P Seal	1900-044-012
Rr O/P Seal	1900-044-012
<i>Paper, Rubber, Small Parts Group</i>	
SF Insert Set (2)	1356-235-001
PTO Gasket	6067-X
Ultra Black 598	22072
SK 4401	

44-01 Chain OE Borg Warner	
1/2 P X 1-1/4 W X 72 Links	HV025
1/2 P X 1.00 W X 62 Links	HV027

Borg Warner 44-04 Ford	
TC 4404	
BK 4404	
<i>Major Bearing Group</i>	
Input Ball Brg	109
Int; Gear	206-L
Rr O/P Rr	208-L
Rr O/P Rr	207-L
Pilot Ball Bush	16006
Frt O/P Shf Rr	SCH1310
Lube Washer	1900-193-005
Lube Washer	1900-193-006
<i>Sealant Group</i>	
Input Seal	1900-044-012
Frt O/P Seal	1900-044-009
Rr O/P Seal	1900-044-009
Adapter Gasket	36086
Ultra Black 598	22072
SK 4404	

44-04 Chain OE Borg Warner	
.4346 P X 1-1/4 W X 74 Links	HV051

Borg Warner 44-05 Ford Explorer	
TCM 4405	
TC 4405	
BK 4405	
<i>Major Bearing Group</i>	
Input Ball Brg	6209A8N
Ball Brg	6206A5 C3
Ball Brg (2)	6306V27
Thrust Brg	1900-132-008
Frt O/P Shf Rr	1000-132-038
Bushing	1345-127-002
<i>Oil Seal Group</i>	
Input Seal	1900-044-009
Frt O/P Seal	1900-044-009
Rr O/P Seal	1300-044-001
<i>Paper, Rubber, Small Parts Group</i>	
SF Insert Set (2)	1356-235-001
Spline Wash (2)	1000-044-012
Small Parts Kit	SP4405-50A
SK 4405	

Borg Warner 44-05 Small Parts Kit	
SP 4405-50	
SP 4405-50A	
Spline Wash (2)	1000-044-012
Snap Ring	1000-139-043
Snap Ring	1000-139-040
Bushing	1345-127-002
SF Insert Set (2)	1356-235-001
Balls (3 Pcs)	1900-109-002
Thrust Brg	1900-132-008
Ret Ring	1900-139-007
Snap Ring	1900-139-034
Ret Ring	1900-139-039
Nuts (2 Pcs)	1900-149-001
Wave Spring	1900-156-006
Washer	1900-193-020

44-05 Chain OE Borg Warner	
.4346 P X 1-1/4 W X 74 Links	HV051

Borg-Warner Master, Bearing and other Kit Content Drawings



Borg Warner 44-06 Ford Bronco & Expedition With Torque on Demand, Electric or Man. Case 4405-000-012, 4405-000-017, 4405-000-020 & 4405-000-023 Only	
TCM4406-TOD	
TC4406-TOD	
<i>Major Bearing Group</i>	
Plantary Ndl Brg	1300-132-015
Thrust Ndl Brg	AXK4060
Thrust Ndl Brg	NTA2233
Frnt O/P Ball Brg Fr	208-LO
Frnt O/P Ball Brg Rr	207-LO
Rr O/P Ball Brg Rr	207-LO
Input Shft Bush	1345-127-002
Rr Ext Hsg Bush	1900-127-011
<i>Oil Seal Group</i>	
Input Seal	1900-044-012
Frnt O/P Seal	1900-044-012
Frnt O/P Seal	1900-044-009
Rr O/P Seal	1900-044-013
Elect-Sft Shft Seal	1300-044-001
<i>Paper, Rubber, Small Parts Group</i>	
SF Insert Set (2)	1356-235-001
Spline Wash (2)	1000-044-012
Ultra Black 598	22072
Small Parts Kit	SP4406-50A
SK4406-TOD	

44-06 Chain OE Borg Warner	
.4346 P X 1-1/4 W X 86 Links TOD	HV052
.4346 P X 1-1/4 W X 86 Links WO	HV053

Borg Warner 44-06 Ford Full Size Truck W/O Torque on Demand, Electric or Man. Case 4405-000-010, -011, -013, -014, -015, -016,- 018, -019, -020, -021, -022 & -024	
TCM4406-WO	
TC4406-WO	
<i>Major Bearing Group</i>	
Plantary Ndl Brg	1300-132-015
Frnt O/P Ball Brg Rr	207-LO
Rr O/P Ball Brg Rr	207-LO
Frnt O/P Ball Brg Fr	211
Input Shft Bush	1345-127-002
<i>Oil Seal Group</i>	
Oil Seal	10114
Oil Seal	18662
Oil Seal	1900-044-012
Oil Seal	1900-044-013
Oil Seal	UE0912E
Shft Rail Seal	1300-044-001
<i>Paper, Rubber, Small Parts Group</i>	
SF Insert Set (2)	1356-235-001
Spline Wash (2)	1000-044-012
Ultra Black 598	22072
Small Parts Kit	SP4406-50B
SK4406-WO	

Borg Warner 44-06 Small Parts Kits	
SP4406-50A	TOD
SP4406-50B	WO
Ret Ring	1900-139-049
Ret Ring	1900-139-043
Thrust Washer	1900-193-035
Ball Set (3 Pc)	1900-109-002
Thrust Race	1900-018-003
Thrust Race	1900-018-004
Snap Ring Set (2 Pc)	1300-139-027
Vent	1300-072-001
Snap Ring	1900-139-043



Borg Warner 44-07 Ford F250 & F350 Truck	
TC 4407	
<i>Major Bearing Group</i>	
Ball Brg	211
Ball Brg	208
Ball Brg	207-L
Ball Brg	308-L
Thrust Brg	NTA2233
Thrust Washer	TRD2233
<i>Seal Group</i>	
Oil Seal (3)	1900-044-012
Oil Seal	UE0912E
<i>Paper, Rubber, Small Parts Group</i>	
SF Inserts (2)	1356-235-001
Spline Washer (2)	1300-160-002
Ultra Black 598	22072
SK4407	

**44-07 Chain
OE Borg Warner**
.5033 P X 1-1/2 W X 84 Links **HV054**

Borg Warner 44-70 GM	
TC 4470	
BK 4470	
<i>Major Bearing Group</i>	
Input Ball Brg	110
Frnt O/P Ball Brg	207-L
Rr Output Ball Brg	208-L
Cyl Roller Brg	RNU204
Ndl Brg	B3012
<i>Seal Group</i>	
Oil Seal	1300-016-001
Oil Seal	1900-044-013
Oil Seal (2)	1900-044-012
<i>Paper, Rubber, Small Parts Group</i>	
Adapter Gasket	36086
O-Ring	AS111
Spline Washer	1300-160-002
Ultra Black 598	22072
SK 4470	

**44-70 Chain
OE Borg Warner**
1/2PX1-1/2WX72Links **HV050**

Borg-Warner Transfer Case Kit Recap Sheet



Kit Number	More Information See Page:	▼
BK1345		22
BK1350-X		23
BK1354		23
BK1356		24
BK1359		25
BK1372		25
BK4404		26
BK4405		26
BK4470		28
K100909		22
K100910		23
K100912		23
K100919		24
K100959		25
K100972		25
PK1345		22
PK1354		23
PK1356		24
SK1305		22
SK1345		22
SK1345-X		22
SK1350		23
SK1350-X		23
SK1354		23
SK1356		24
SK1356-XJ		24
SK1359		25
SK1372-XJ		25
SK4401		26
SK4404		26
SK4405		26
SK4406-TOD		27
SK4406-WO		27
SK4407		28
SK4470		28
SP1345-50		22
SP1345-50A		22
SP1356-50		24
SP1356-50A		24
SP1372-50		25
SP1372-50A		25
SP4405-50		26
SP4405-50A		26
SP4406-50A		27

Kit Number	More Information See Page:	▼
SP4406-50B		27
TC1305		22
TC1305-B		22
TC1305-XJ		22
TC1345		22
TC1345-XJ		22
TC1350		23
TC1354		23
TC1356		24
TC1356-XJ		24
TC1359		25
TC1372-XJ		25
TC4401		26
TC4404		26
TC4405		26
TC4406-TOD		27
TC4406-WO		27
TC4407		28
TC4470		28
TCM1345-XJ		22
TCM1356		24
TCM1356-XJ		24
TCM4405		26
TCM4406-TOD		27
TCM4406-WO		27

Dana Corporation

**Ford, Jeep, and
International**

Major Kit Drawings-Parts List Guide Page 31
All Kits and Assemblies-Recap Sheet Page 37



Dana Transfer Case Kit Drawing Page Number Index

- Major Kit Recommended Stock for a Rebuilder/Distributor

Dana Model 18 Jeep & IHC/Navistar	32
Parts List See Drawing Page: ▲	
<i>Master Overhaul Kit</i>	TCM 18
<i>Deluxe Bearing & Sealant</i>	TC 18

Dana Model 24, 23 Ford 1962-72	34
Parts List See Drawing Page: ▲	
<i>Deluxe Bearing & Sealant</i>	TC 24
<i>Basic Bearing & Sealant</i>	BK 24

Dana Model 18 Early GM <i>Isolated</i>	32
Parts List See Drawing Page: ▲	
<i>Deluxe Bearing & Sealant.</i>	TC 18-G

Dana Model 28, Ford 1989 & After	35
Parts List See Drawing Page: ▲	
● <i>Super Bearing & Sealant</i>	TC 28-FXJ
● <i>Deluxe Bearing & Sealant</i>	TC 28-F
<i>Basic Bearing & Sealant</i>	BK 28

Dana Model 20 1966-77	32
Parts List See Drawing Page: ▲	
<i>Master Overhaul Kit</i>	TCM 20
<i>Deluxe Bearing & Sealant</i>	TC 20

Dana Model 300 1975-83	35
Parts List See Drawing Page: ▲	
<i>Super Master Overhaul Kit</i>	TCM 300-XJ
<i>Master Overhaul Kit</i>	TCM 300
<i>Deluxe Bearing & Sealant</i>	TC 300
<i>Basic Bearing & Sealant</i>	BK 300

Dana Model 20 Universal Ford 1962-79	33
Parts List See Drawing Page: ▲	
<i>Super Master Overhaul Kit</i>	TCM 20-FXJ
<i>Deluxe Bearing & Sealant</i>	TC 20-FXJ

Dana Model 20 Ford Early 1962-72	33
Parts List See Drawing Page: ▲	
<i>Super Master Overhaul Kit</i>	TCM 20-F
<i>Deluxe Bearing & Sealant</i>	TC 20-F

Dana Model 20 Ford Late 1973-77	33
Parts List See Drawing Page: ▲	
<i>Super Master Overhaul Kit</i>	TCM 20-FB
<i>Deluxe Bearing & Sealant</i>	TC 20-FB

Dana Model 21, Ford 1965-74	34
Parts List See Drawing Page: ▲	
<i>Deluxe Bearing & Sealant</i>	TC 21-FHD
<i>Basic Bearing & Sealant</i>	BK 21



Dana Master, Bearing and other Kit Content Drawings

Dana Model 18 Jeep & International	
TCM18	
TC18	
<i>Major Bearing Group</i>	
Frt O/P Shf Frt	206
Rr O/P Shf Frt	14131
Rr O/P Shf Frt Cup	14276
Rr O/P Shf Rr Cone	14131
Rr O/P Shf Rr Cup	14276
Frt Int Shaft Frt	F54970
Frt Int Shaft Rr	F54970
Int. Gear Ndl Set	Q13367-48
<i>Oil Seal Group</i>	
Frt O/P	15450
Rr O/P	15450
Shift Shaft (2)	6229
<i>Paper, Rubber, Small Parts Group</i>	
Gasket Set	GTC18-55
Gasket Set	GK18-55
Small Parts Kit	SP18-50AK
SK18	
K100914	

Dana Model 20 Jeep & International	
TCM20	
TC20	
<i>Major Bearing Group</i>	
Frt O/P Shf Frt Cone	14116
Frt O/P Shf Frt Cup	14276
Frt O/P Shf Rr Cone	14116
Frt O/P Shf Rr Cup	14276
Rr O/P Shf Frt Set	258-SET
Rr O/P Shf Rr Cone	15117
Rr O/P Shf Rr Cup	15245
Pilot Ndl Set	Q8128-16
Int. Gear Ndl Set	Q13367-48
<i>Oil Seal Group</i>	
Frt O/P	15655
Rr O/P	15655
Shift Shaft (2)	6229
<i>Paper, Rubber, Small Parts Group</i>	
Gasket Set	GTC20-55
Gasket Set	GK20-55
Small Parts Kit	SP20-50B
SK 20	
K100915	

Dana Model 18 GM (Early & Isolated)	
TC18-G	
<i>Major Bearing Group</i>	
Frt O/P Shf Frt Cone	14116
Frt O/P Shf Frt Cup	14276
Rr O/P Shf Frt Set	258-SET
Rr O/P Shf Rr Cone	15117
Rr O/P Shf Rr Cup	15245
Frt Int Shaft Frt	F54970
Frt Int Shaft Rr	F54970
Int. Gear Ndl Set	Q13367-48
<i>Sealant Kit</i>	
Deluxe Sealant Kit	SK18

Dana 18, & 20 Complete Small Parts Kits	
Dana 18	SP18-50B
Dana 20	SP20-50

Dana Master, Bearing
and other Kit Content Drawings



Dana 20 Ford

Dana Model 20 Ford Universal 1966-77	
TCM20-FXJ	
TC20-FXJ	
<i>Major Bearing Group</i>	
Frt O/P Shf Frt Cone	14116
Frt O/P Shf Frt Cone	14131
Frt O/P Shf Frt Cup	14276
Frt O/P Shf Rr Cone	14116
Frt O/P Shf Rr Cone	14131
Frt O/P Shf Rr Cup	14276
Rr O/P Shf Frt Set	258-SET
Rr O/P Shf Rr Cone	15117
Rr O/P Shf Rr Cup	15245
Pilot Ndl Set	Q8128-16
Int. Gear Ndl Set	Q13367-48
<i>Oil Seal Group</i>	
Frt O/P	15655
Rr O/P	15655
Shift Shaft (2)	6229
<i>Paper, Rubber, Small Parts Group</i>	
Gasket Set	C6T27 153C
Small Parts Kit	SP20-50A
SK 20-F	

Dana Model 20 Ford Kits 20-F for Early 1966-72 Kits 20-FB for Late 1973-77	
TCM20-F	
TC20-F	
TCM20-FB	
TC20-FB	
<i>Major Bearing Group</i>	
Frt O/P Shf Frt Cone	14116
Frt O/P Shf Frt Cone	14131
Frt O/P Shf Frt Cup	14276
Frt O/P Shf Rr Cone	14116
Frt O/P Shf Rr Cone	14131
Frt O/P Shf Rr Cup	14276
Rr O/P Shf Frt Set	258-SET
Rr O/P Shf Rr Cone	15117
Rr O/P Shf Rr Cup	15245
Pilot Ndl Set	Q8128-16
Int. Gear Ndl Set	Q13367-48
<i>Paper, Rubber, Small Parts Group</i>	
Gasket Set	C6T27 153C
Small Parts Kit	SP20-50A



Dana Master, Bearing and other Kit Content Drawings

Dana Model 21 Ford 1965-74	
TC21-FHD	
BK 21	
<i>Major Bearing Group</i>	
Frt O/P Shf Frt Cone	14131
Frt O/P Shf Frt Cup	14276
Frt O/P Shf Rr Cone	14131
Frt O/P Shf Rr Cup	14276
Rr O/P Shf Frt Set	258-SET
Rr O/P Shf Rr Cone	M86649
Rr O/P Shf Rr Cup	M86610
Int. Shaft Frt	1207-L
Int. Shaft Rr	1207-L
Int. Shaft Frt	207-L
Int. Shaft Rr	207-L
<i>Sealant Group</i>	
Frt O/P	15699
Rr O/P	15655
Shift Shaft	6229
Gasket Set	C6TZ-7153B
SK 21-F	

Dana Model 23, 24 Ford 1962-72	
TC 24	
BK 24	
<i>Major Bearing Group</i>	
Input Shaft	307-L
Frt O/P Shf Frt	207-L
Frt O/P Shf Rr	207-L
Rr O/P Shf Frt	307-L
Rr O/P Shf Rr	207-L
Int. Shaft Rr	207-L
Int. Gear Ndl Set	Q8128-16
<i>Sealant Group</i>	
Input	21100
Frt O/P	21100
Rr O/P	21100
Shift Shaft Set	7443-2
Gasket Set	B9TZ-7153A
SK 24	

Dana Master, Bearing and other Kit Content Drawings



Dana Model 28 Ford 1989 & After	
TC28-FXJ	
TC28-F	
BK 28	
<i>Major Bearing Group</i>	
Input Ball Brg	F09Z7065A
Input Ball Brg	209
Frt O/P Shf Frt	108
Frt O/P Shf Rr	209
Rr O/P Shf Frt	209
Cage Ndl	C6TZ-3123A
Brg Set (3)	
Bushing	F09Z-7120A
Bushing	F09Z-7120B
Int. Gear Bushing	PAPZ2416P
Visc Coupling Brg	50BG07S1
<i>Sealant Group</i>	
Input	17353
Frt O/P	18623
Rr O/P	14635
Ultra Black 598	22072
O-Ring	AS029
SK 28-F	

Dana 28 Chain OE Borg Warner	
3/8 P X 1-1/4 W X 86 Llnks	HV048

Dana Model 300 Jeep & International Scout	
TCM300-XJ	
TCM300	
TC300	
BK 300	
<i>Major Bearing Group</i>	
Input Ball Brg	209
Frt O/P Shf Frt Cone	M86649
Frt O/P Shf Frt Cup	M86610
Frt O/P Shf Rr Cone	M86649
Frt O/P Shf Rr Cup	M86610
Rr O/P Shf Frt Set	258-SET
Rr O/P Shf Frt Cone	25880
Rr O/P Shf Rr Cone	15117
Rr O/P Shf Rr Cup	15245
Rear O/P Frt	JH1612
Int. Gear Ndl Set	Q13367-48
<i>Oil Seal Group</i>	
Input Seal	4269183
Input Seal Set (2)	19236
Frt & Rr O/P (2)	15655
Shift Shaft (2)	6229
<i>Paper, Rubber, Small Parts Group</i>	
Gasket	10050
Ret Ring Kit	300-50RK
Shim Set	0933743
Shim Set	329025X
SF Insert Set	8131670-4
Nut (2 Pcs)	801367
Washer (2 Pcs)	4004913
Thimble (2 Pcs)	934281
Spring	8131676
O-Ring	942114
Shaft	842115

SK 300	
K100916:	
SP300-50	
Input Seal	4269183
Input Seal Set (2)	19236
Frt & Rr O/P (2)	15655
Shift Shaft (2)	6229
Gasket	10050
Ret Ring Set	300-50RK
Shim Set	0933743
Shim Set	329025X
SF Insert Set	8131670-4



Dana Bearing Kit Component Drawings

Dana 738A 420412-X	
TC420411-X	
<i>Major Bearing Group</i>	
Ball Brg	122-L
Ball Brg	217-SL
Ball Brgs (3)	312
Ball Brg	314
Ball Brgs (2)	315
Journal Roller Brg	J401648

Dana 738B, 738C, 738D, 738E 420411-X	
TC420412-X	
<i>Major Bearing Group</i>	
Ball Brgs (4)	312
Ball Brg	314
Ball Brgs (2)	315
Journal Roller Brg	J401648

Dana 784 420482-X	
TC420482-X	
<i>Major Bearing Group</i>	
Ball Brgs (4)	312
Ball Brg (2)	314
Ball Brgs (2)	315
Journal Roller Brg	J401648
Needle Roller Brg	WJ162116

Dana 785, 792 420483-X	
TC420483-X	
<i>Major Bearing Group</i>	
Ball Brgs (5)	312
Ball Brg (2)	314
Ball Brgs (2)	315
Journal Roller Brg	J401648
Needle Roller Brg	WJ162116

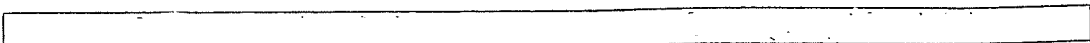

Dana Transfer Case Kit
Recap Sheet



Kit Number	More Information See Page	▼
BK21		34
BK24		34
BK28		35
BK300		35
K100914		32
K100915		32
K100916		35
SK18		32
SK20		32
SK20-F		33
SK21-F		34
SK24		34
SK28-F		35
SK300		35
SP18-50B		32
SP20-50		32
SP300-50		35
TC18		32
TC18-G		32
TC20		32
TC20-F		33
TC20-FB		33
TC20-FXJ		33
TC21-FHD		34
TC24		34
TC28-F		35
TC28-FXJ		35
TC300		35
TC420411-X		36
TC420412-X		36
TC420482-X		36
TC420483-X		36
TCM18		32
TCM20		32
TCM20-F		33
TCM20-FB		33
TCM20-FXJ		33
TCM300		35
TCM300-XJ		35

New Process, New Venture

**General Motors, Dodge, Jeep
International & Ford Applications**

Major Kit Drawings-Parts List Guide Page 39-40

All Kits and Assemblies-Recap Sheet Page 53



New Process/New Venture Transfer Case Kit Drawing Page Number Index

- Major Kit Recommended Stock for a Rebuilder/Distributor

NP 200, 201 Chrysler	41
Parts List See Drawing Page: ▲	
<i>Deluxe Bearing & Sealant</i>	TC 200

NP 202 International Scout	41
Parts List See Drawing Page: ▲	
<i>Basic Bearing & Sealant</i>	BK 202- NP

NP 203 Universal	42
Parts List See Drawing Page: ▲	
● <i>Master Overhaul Kit</i>	TCM 203- U
● <i>Deluxe Bearing & Sealant</i>	TC 203- U

NP 203 Ford	43
Parts List See Drawing Page: ▲	
<i>Super Master Overhaul Kit</i>	TCM 203- F
<i>Deluxe Bearing & Sealant</i>	TC 203- F

NP 203 /GM, Dodge, International	43
Parts List See Drawing Page: ▲	
<i>Super Master Overhaul Kit</i>	TCM 203- G
<i>Deluxe Bearing & Sealant</i>	TC 20- G

NP 205 Universal Direct Mount	44
Parts List See Drawing Page: ▲	
● <i>Super Master Overhaul Kit</i>	TCM 205- UDM
● <i>Deluxe Bearing & Sealant</i>	TC 205- UDM

NP 205 1987 & Before Dodge Direct Mount	45
Parts List See Drawing Page: ▲	
● <i>Master Overhaul Kit</i>	TCM 205- GDM
● <i>Deluxe Bearing & Sealant</i>	TC 205- GDM

NP 205 1988 & After Dodge Direct Mount	44
Parts List See Drawing Page: ▲	
<i>Master Overhaul Kit</i>	TCM 205- D
<i>Deluxe Bearing & Sealant</i>	TC 205- D

NP 205 Ford Direct Mount	45
Parts List See Drawing Page: ▲	
<i>Master Overhaul Kit</i>	TCM 205- FDM
<i>Deluxe Bearing & Sealant</i>	TC 205- FDM

NP 205 Ford Midship Remote Mount	46
Parts List See Drawing Page: ▲	
<i>Master Overhaul Kit</i>	TCM 205
<i>Deluxe Bearing & Sealant</i>	TC 205

NP 205 Universal, Dodge, Ford, GM Remote Mount	46
Parts List See Drawing Page: ▲	
<i>Master Overhaul Kit</i>	TCM 205- DFG
<i>Deluxe Bearing & Sealant</i>	TC 205- DFG

NP 207 Universal	48
Parts List See Drawing Page: ▲	
● <i>Master Overhaul Kit</i>	TCM 207
● <i>Deluxe Bearing & Sealant</i>	TC 207
● <i>Basic Bearing & Sealant</i>	BK 207

NP 208 Universal	47
Parts List See Drawing Page: ▲	
● <i>Master Overhaul Kit</i>	TCM 208
● <i>Deluxe Bearing & Sealant</i>	TC 208- XJ
● <i>Basic Bearing & Sealant</i>	BK 208

NP 229, 228 Series Jeep	47
Parts List See Drawing Page: ▲	
● <i>Master Overhaul Kit</i>	TCM 228/9
● <i>Deluxe Bearing & Sealant</i>	TC 228/9

NP 231, Universal with Double Row Input Ball Brg & C/S Welsh Plug	48
Parts List See Drawing Page: ▲	
● <i>Master Overhaul Kit</i>	TCM 231
● <i>Deluxe Bearing & Sealant</i>	TC 231



New Process/New Venture Transfer Case Kit Drawing Page Number Index

- Major Kit Recommended Stock for a Rebuilder/Distributor

NP 231 HD with Double Row Input Ball Brg but w/o C/S Welsh Plug	49
Parts List See Drawing Page ▲	
● <i>Master Overhaul Kit</i>	TCM 231-HD
<i>Deluxe Bearing & Sealant</i>	TC 231-C

NP 231, 233-HD Single or Double Row Input Ball Brg 1996 & After	49
Parts List See Drawing Page ▲	
● <i>Master Overhaul Kit</i>	TCM 231/3-HD
● <i>Deluxe Bearing & Sealant</i>	TC 231/3-D

NP 231, 233 HD Single Row Ball Brg Input 1996 & After	49
Parts List See Drawing Page ▲	
<i>Master Overhaul Kit</i>	TCM 233
<i>Deluxe Bearing & Sealant</i>	TC 233

NP 241 1992 & Before	50
Parts List See Drawing Page ▲	
● <i>Deluxe Bearing & Sealant</i>	TC 241

NP 241 Dodge Diesel 1994 & After	50
Parts List See Drawing Page ▲	
<i>Deluxe Bearing & Sealant</i>	TC 241-DHD

NP 241 Gas 1993 & After	50
Parts List See Drawing Page ▲	
● <i>Deluxe Bearing & Sealant</i>	TC 241-A

NP 242 Universal	51
Parts List See Drawing Page ▲	
● <i>Deluxe Bearing & Sealant</i>	TC 242

New Venture 243 GM	51
Parts List See Drawing Page ▲	
<i>Deluxe Bearing & Sealant</i>	TC 243

NP 249 Jeep See Assembly Numbers with Drawing	52
Parts List See Drawing Page ▲	
<i>Deluxe Bearing & Sealant</i>	TC 249
<i>Deluxe Bearing & Sealant</i>	TC 249-JA

New Process Master, Bearing
And other Kit Content Drawings



New Process 200, 201 Dodge Chrysler	
TC 200	
<i>Major Bearing Group</i>	
Idler Gear Frt	205-Set
Idler Gear Rr	205-Set
Input Shaft Frt	307-L
Front O/P Shf Frt	307-L
Rear O/P Shf	307-L
Rear O/P Shf Frt	3720-80
Rear O/P Shf Rr	205-Set
C/S Pilot Ndl Set	QBR23549-30
Low Gear Ndl Set	C1960Q-70
Rear In Ndl Set	C1960Q-70
<i>Oil Seal Group</i>	
Input Seal	1300-016-001
Frt O/P Seal	1900-044-012
Rr O/P Seal	1900-044-012
<i>Sealant Group</i>	
Input Seal	2954128
Front O/P Seal	2954128
Rear O/P Seal	2954128
Shift Shft Seal Set	3496234-2
200, 201 Gkt Set	GS201-55
SK 200	

New Process 202 International Scout	
BK 202- NP	
<i>Major Bearing Group</i>	
Input Shaft Frt	307-L
Front O/P Shf Frt	307-L
Rear O/P Shf	307-L
Rear O/P Shf Frt	B3216
Rear O/P Shf Rr	BCE2816
Idler Thrust Brg	NTA2840
C/S Pilot Ndl Set	QBR23549-15
Idler Gear Ndl Set	C1086Q-82
Rear In Ndl Set	C1960Q-70
<i>Oil Seal Group</i>	
Input Seal	1300-016-001
Frt O/P Seal	1900-044-012
Rr O/P Seal	1900-044-012
<i>Sealant Group</i>	
Input Seal	2954128
Front O/P Seal	2954128
Rear O/P Seal	2954128
Shift Shft Seal Set	3496234-2
200, 201 Gkt Set	GS201-55
SK 200	

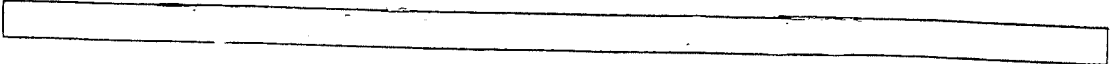



New Process Master, Bearing And other Kit Content Drawings

New Process 203

NP 203 Universal Master & Bearing Kits	
TCM203-U	
TC203-U	
TC203-XA	
BK203	
<i>Major Bearing Group</i>	
Input Shaft Frt	1210-L
Input Shaft Frt	1210-L
Input Shaft Frt	210-L
Input Shaft Frt	210-L
Frt O/P Shf Frt	307-L
Frt O/P Shf Frt	307-L
Frt O/P Shf Rr	BCE2816
Diff Hsg Frt	SCE3616
<i>Needle Set Group</i>	
C/S Ndl Set	QAR29523-102
Frt O/P Ndl Set	C1086Q-132
Carrier Ndl Set	Q8113-132
<i>Oil Seal Group</i>	
Dodge Input	4057006
Ford & GM Input	4269183
Front O/P	13491
Rear O/P	18872
GM Only Rear O/P	21061
<i>Paper, Rubber & Small Parts</i>	
Adpt & Case Gkg Set	GS203-55
Spline Seal Set	203-SWS
O-Ring Set	203-OK
Adapter Ring Seal	203001
Pump Ring Seal	205004
Muffler Pad	11930
Lube Washer	3821370
Poppet Repair Kit	203-PRK
Retaining Ring Set	203-RRS
Roll Pin Set	203-RPS
Snap Ring Set	203-RSU

NP 203 Universal Small Parts Kits	
SP203-50	
SP203-50A	
SP203-50N	
C/S Needle Set	QAR29523
Frt O/P Shf Ndl Set	C1086Q
Carrier Needle Set	Q8113
Spline Seal Set	203-SWS
O-Ring Set	203-OK
Adapter Ring Seal	203001
Pump Ring Seal	205004
Muffler Pad	11930
Lube Washer	3821370
Poppet Repair Kit	203-PRK
Retaining Ring Set	203-RRS
Roll Pin Set	203-RPS
Snap Ring Set	203-RSU

NP 203 Chains Borg Warner U.S.A.	
3/8 P X 2.50 W X 98 Links	HV005
1/2 P X 2.00 W X 72 Links	HV009

NP 203 Universal Sealant Kit	
SK203-U	
K100900U	
Dodge Input	4057006
Ford & GM Input	4269183
Front O/P	13491
Rear O/P	18872
Rear O/P	18662
GM Only Rear O/P	21061
Adpt & Case Gkg Set	GS203-55
Spline Seal Set	203-SWS
O-Ring Set	203-OK
Adapter Ring Seal	203001
Pump Ring Seal	205004
Muffler Pad	11930

**Surplus-New Process Original
203 Input Gear
Part No. 13343**

13343

New Process Master, Bearing and other Kit Content Drawings



New Process 203

New Process 203 Popular Ford 3/4 Ton F250 1974-76 Only use -FX	
TCM203-F	
TC203-F	
TC203-FX	
BK203F	
<i>Major Bearing Group</i>	
Input Shaft Frt	1210-L
Input Shaft Frt	1210-L
Input Shaft Frt	210-L
Input Shaft Frt	210-L
Frt O/P Shf Frt	307-L
Frt O/P Shf Frt	307-L
Frt O/P Shf Rr	BCE2816
Diff Hsg Frt	SCE3616
C/S Ndl (102 Pc Set)	QAR29523
Frt O/P Ndl Set	C1086Q-132
Carrier Ndl Set	QB113-132
<i>Sealant & SPK Group</i>	
All Popular Ford	SK203-F
All Popular Ford	K100900F
3/4 Ton 1974-76	SK-203-FX
Small Parts Kit	SP203-50A

New Process 203 Dodge & GM Early GM with Cast Iron Tailhousing Only use -GX	
TCM203-G	
TC203-G	
TC203-GX	
BK203G	
<i>Major Bearing Group</i>	
Input Shaft Frt	1210-L
Input Shaft Frt	1210-L
Input Shaft Frt	210-L
Input Shaft Frt	210-L
Frt O/P Shf Frt	307-L
Frt O/P Shf Frt	307-L
Frt O/P Shf Rr	BCE2816
Diff Hsg Frt	SCE3616
C/S Ndl (102 Pc Set)	QAR29523
Frt O/P Ndl Set	C1086Q-132
Carrier Ndl Set	QB113-132
<i>Sealant & SPK Group</i>	
All Popular Ford	SK203-G
All Popular Ford	K100900G
3/4 Ton 1974-76	SK-203-GX
Small Parts Kit	SP203-50A

NP 203 Ford Sealant Kit	
SK203-F	
SK203-FX	
K100900F	
<i>Ford Oil Seal Group</i>	
Ford Input	4269183
Ford Input	19273
Front O/P	13491
Rear O/P	18662
250 Frt Output	D4TZ7B215C
250 Rr Output	D6TZ7B215C
<i>Paper, Rubber & Small Parts</i>	
Adpt & Case Gkg Set	GS20355F
Adpt & Case Gkg Set	GS20355FX
Spline Washer Set	203-SWS
O-Ring Set	203-OK
Adapter Ring Seal	203001
Pump Ring Seal	205004
Muffer Pad	11930

NP 203 GM & Dodge Sealant Kit	
SK203-G	
SK203-GX	
K100900	
<i>GM Oil Seal Group</i>	
GM Input	4269183
Front O/P	13491
Rear O/P	21061
Front O/P	13090
Rear O/P	21352
<i>Paper, Rubber & Small Parts</i>	
Adpt & Case Gkg Set	GS20355G
Adpt & Case Gkg Set	GS20355GX
Spline Washer Set	203-SWS
O-Ring Set	203-OK
Adapter Ring Seal	203001
Pump Ring Seal	205004
Muffer Pad	11930



New Process Master, Bearing and other Kit Content Drawings

New Process 205

New Process 205 Universal Direct Mount except HD Dodge 1988 & After	
TCM205-UDM	
TC205-UDM	
<i>Major Bearing Group</i>	
Input Sht Frt 35 mm	307-L
Input Sht Frt 50 mm	1210-L
Frt O/P Shf Frt	307-L
Rr O/P Shf Rr	307-L
Gear Idler Frt	205-SET
Gear Idler Rr	205-SET
Rr O/P Shf Frt	B3216
Rr Outer	BCE2816
Pilot Ndl (15 Pc/Set)	QAR29523
Low & Rr Ndl (128 Pc/Set)	QBR23549
<i>Universal Popular Oil Seals</i>	
Input	4269183
Input	21213
Front O/P	13491
Rear O/P	21213
Chrysler Only	19762
Chrysler Only	19762
Ford Only	18872
GM Only	18992
Shift Shft Seal Set	7443-2
<i>Paper, Rubber Small Parts Group</i>	
Adpt & Case Gkg Set	GS20555U
Spline Washer	611689
O-Ring & Washer	205-RP
Small Parts Kit	SP205-50A
SK 205-UDM	

NP 205 Universal Small Parts Kits	
SP205-50	
SP205-50A	
Pilot Ndl Set	QAR29523-15
Low & Rr Ndl Sets	QBR23549-128
Poppet Repair Kit	205-PRK
Pre-Load Shim Set	205-110
Snap Ring & Washer Set	205-RWS
Low Gear Spacer Set	205-213
Roll Pin Set	205-219

New Process 205 HD Dodge Direct Mount 1988 & After	
TCM205-D	
TC205-D	
BK205-D	
<i>Major Bearing Group</i>	
Input Sht Frt	1210-L
Input Sht Frt	210-L
Frt O/P Shf Frt	307-L
Rr O/P Shf Rr	307-L
Gear Idler Frt	205-SET
Gear Idler Rr	205-SET
Rr O/P Shf Frt	SCE2416
Rr Outer	BCE2816
Pilot Ndl (15 Pc Set)	QAR29523
Low & Rr Ndl (128 Pc Set)	QBR23549
<i>Universal Popular Oil Seals</i>	
Input	4269183
Front O/P	13970
Rear O/P	21213
Chrysler	13557-2
Shift Shft Seal Set	7443-4
<i>Paper, Rubber Small Parts Group</i>	
Adpt & Case Gkg Set	GS205-55D
Spline Washer	611689
O-Ring & Washer	205-RP
O-Ring	AS216
Small Parts Kit	SP205-50K
SK 205-D	
NP 205 Needle Set	
SP205-50N	
Pilot Ndl Set	QAR29523-15
Low & Rr Ndl Sets	QBR23549-128

New Process Master, Bearing and other Kit Component Drawings



New Process 205

New Process 205 Direct Mount Ford	
TCM205-FDM	
TC205-FDM	
BK205-FDM	
<i>Major Bearing Group</i>	
Input Sht Frt	1210-L
Input Sht Frt	210-L
Frt O/P Shf Frt	307-L
Rr O/P Shf Rr	307-L
Gear Idler Frt	205-SET
Gear Idler Rr	205-SET
Rr O/P Shf Frt	B3216
Rr Outer	BCE2816
Pilot Ndl (15 Pc Set)	QAR29523
Low & Rr Ndl (128 Pc Set)	QBR23549
<i>Sealant & Small Parts Kits</i>	
<i>Deluxe Kit</i>	SK205-FDM
<i>Basic Kit</i>	K100957
<i>Small Parts Kit</i>	SP205-50A

New Process 205 Direct Mount GM 350 Auto & Dodge use -GDM GM 400 Auto use -4GDM Kits	
TCM205-GDM	
TC205-GDM	
TC205-4GDM	
BK205-4GDM	
<i>Major Bearing Group</i>	
Input Sht Frt	307-L
Input Sht Frt	1210-L
Input Sht Frt	210-L
Frt O/P Shf Frt	307-L
Rr O/P Shf Rr	307-L
Gear Idler Frt	205-SET
Gear Idler Rr	205-SET
Rr O/P Shf Frt	B3216
Rr Outer	BCE2816
Pilot Ndl (15 Pc Set)	QAR29523
Low & Rr Ndl (128 Pc Set)	QBR23549
<i>Sealant & Small Parts Kits</i>	
<i>Deluxe Kit</i>	SK205-GDM
<i>Deluxe Kit</i>	SK205-4GDM
<i>Basic Kit</i>	K100924G
<i>Small Parts Kit</i>	SP205-50A

NP 205 Ford Direct Mount Sealant Kit	
SK205-FDM	
K100957	
Input Oil Seal	4269183
Input Oil Seal	21213
Frt & Rr O/P Seals	21213-2
In, Frt & Rr O/P Seals	21211-3
Ford Only Seal	18872
Shift Shft Seal Set	7443-2
Adpt & Case Gkg Set	GS205055F
Spline Washer	611689
Ring Seal	205004
O-Ring	AS216

NP 205 GM Direct Mount Dodge Direct Mount 1987 & before Sealant Kit	
SK205-GDM	
SK205-4GDM	
K100924G	
K100901	
Input	4269183
GM Input Only	18992
Input	21213
Front O/P	13491
Rear O/P	19760
TM400 GM Only	19760
Frt & Rear O/P	21213-2
Shift Shft Seal Set	7443-2
In, Frt & Rr O/P Seals	21211-3
Adpt & Case Gkg Set	GS20555G
Adpt & Case Gkg Set	205-55GX
Spline Washer	611689
Ring Seal	205004
O-Ring	AS216

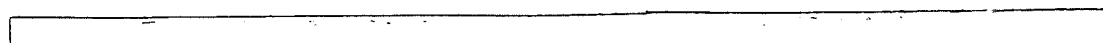



New Process Master, Bearing and other Kit Component Drawings

New Process 205 Remote Mount

New Process 205 Ford Midship Remote Mount	
TCM 205	
TC-205	
BK 205	
<i>Major Bearing Group</i>	
Input Sht Frt	307-L
Frt O/P Shf Frt	307-L
Rr O/P Shf Rr	307-L
Gear Idler Frt	205-SET
Gear Idler Rr	205-SET
Rr O/P Shf Frt	B3216
Rr Outer	BCE2816
Pilot Ndl (15 Pc Set)	QAR29523
Low & Rr Ndl (128 Pc Set)	QBR23549
<i>Sealant & Small Parts Kits</i>	
<i>Deluxe Kit</i>	SK205
<i>Basic Kit</i>	K100947
<i>Small Parts Kit</i>	SP205-50A

NP 205 Universal Remote Mount Ford, GM & Dodge	
TCM 205-DFG	
TC205-DFG	
<i>Major Bearing Group</i>	
Input Sht Frt	1307-L
Frt O/P Shf Frt	307-L
Rr O/P Shf Rr	307-L
Gear Idler Frt	205-SET
Gear Idler Rr	205-SET
Rr O/P Shf Frt	B3216
Rr Outer	BCE2816
Pilot Ndl (15 Pc Set)	QAR29523
Low & Rr Ndl (128 Pc Set)	QBR23549
<i>Sealant & Small Parts Kits</i>	
<i>Deluxe Kit</i>	SK205-DFG
<i>Small Parts Kit</i>	SP205-50A

NP 205 Ford Remote Mount Sealant Kits	
SK 205-DFG	
SK 205	
K 1 00957	
Input Oil Seal	21213
Input Oil Seal	13970
Frt & Rr O/P Seals	21213-2
In, Frt & Rr O/P Seals	21211-3
Frt O/P Seal	19762
Rr O/P Seal	19762
Shift Shft Seal Set	7443-2
Adpt & Case Gkg Set	2050-55R
Adpt & Case Gkg Set	2050-55RX
Spline Washer	611689
Ring Seal	205004
O-Ring	AS216

NP 205 Universal Small Parts Kits	
SP205-50	
SP 205-50A	
Pilot Ndl Set	QAR29523-15
Low & Rr Ndl Sets	QBR23549-128
Poppet Repair Kit	205-PRK
Pre-Load Shim Set	205-110
Snap Ring & Washer Set	205-RWS
Low Gear Spacer Set	205-213
Roll Pln Set	205-219

New Process Master, Bearing
and other Kit Component Drawings



Universal New Process Model 208
Dodge, GM & Jeep including 229, 228, 219, 218, 129, 128, 119, & 118

NP 208 Universal	
TCM208	
TC208-XJ	
BK 208	
<i>Major Bearing Group</i>	
Case Input	HK5020-2
Frt O/P Shf Frt	SCE2816
Frt O/P Shf Rr	SCE2416
Rr O/P Shf Rr	207
Drive Gear Spkt	SCE2012
O/P Thst Brgs (2 Pcs)	NTA2840
M/S Thrust Brg	NTA2435
Sproket Carrier	C1086Q-138
Input Gear Thst Brg	AXK5070
<i>Sealant & Small Parts Kits</i>	
Deluxe Kit	SK208-XJ
Basic Kit	K100908
SF Insert Set	SFI-208
Small Parts Kit	SP208-50A

NP 228, 229 Series Jeep W & W/O Viscous Coupler	
TCM228/9	
TC228/9	
BK 228/9X	
<i>Major Bearing Group</i>	
Case Input	HK5020-2
Input Thrust Brg	16027
Frt O/P Shf Frt	SCE2816
Frt O/P Shf Rr	SCE2416
Rr O/P Shf Frt	SCE3612
Rr O/P Shf Rr	207
Drive Gear Spkt	SCE2012
O/P Thrt Brg Set	NTA2840-2
O/P Thrt Race Set	TRA2840-2
O/P Thrt Race Set	TRC2840-2
M/S Thrust Brg	NTA2435
Pilot Ndl (15 Pc Set)	QAR29523
Slide Gear Car	C1086Q-82
Sproket Carrier	C407Q-120
<i>Sealant & Small Parts Kits</i>	
Deluxe Kit	SK228/9
Basic Kit	K100906
SF Insert Set	SFI-228/9
Small Parts Kit	SP228/950A

208 & 228/9 Sealant Kits	
SK208-XJ	
K100908	
SK228/9	
K100906	
Input	4269183
Frt & Rr O/P	18662-2
Rear O/P	18992
Oil Pump Hqs Seal	22306B
Adpt Gasket Set	AG208-55
Spline Wash Set	611689-2
O-Ring Set	208-OK
O-Ring Set	228/9-OK
Ultra Black 598	22072

228, 229 Small Parts Kits	
SP228/9-50	
Input Thrust Brg	16027
O/P Ndl Assembly	2840-ASM
M/S Thrust Brg	SPB208-50T
Pilot Ndl (15 Pc Set)	QAR29523
Slide Gear Carrier	C1086Q-82
Sproket Carrier	C407Q-120
Spline Washer Set	611689-2
Ring, Wsher & Spacer Set	SP228/9-50A
Shift Fork Insert Set	SFI-228/9

NP OE 208, 228, 229 Chain:	
1/2 P X 1-1/4 W X 84 Links	HV012
1/2 P X 1-1/4 W X 72 Links	HV014
3/8 P X 1-3/4 W X 98 Links	HV015

208, 228/9 Shift Fork Inserts Sets	
SFI-208	
SFI-228/9	
Insert	14037965
Inserts (4 Pcs)	14037966
Inserts (7 Pcs)	14037966
Insert	14095680

NP 208 Ring Gear Bushing	
Chrysler 4167958	4167958



New Process Master, Bearing and other Kit Content Drawings

Universal New Process Model 207
231 Jeep & GM Units with Welch Plug -1995 & before

TCM 207	
TC207	
BK 207	
<i>Major Bearing Group</i>	
Case Input Brg Set	HK4020-2
Frt O/P Shf Frt	206
Rr O/P Shf Rr	206
Main Shaft Pilot	B228
Dr. Sprocket (2 Pcs)	B3210
Frt O/P Shf Rr	BH1810
Ndl Thrust Brg	NTA3244
Ndl Thrust Washer	TRC3244
<i>Sealant & Small Parts Kits</i>	
Deluxe Kit	SK207
Basic Kit	K100907
Shift Fork Insert Set	SFI-207
Small Parts Kit	SP207-50

TCM 231	
TC231	
BK 231	
<i>Major Bearing Group</i>	
Input	BD508
Frt O/P Shf Frt	206
Frt O/P Shf Rr	SCE2416
Rr O/P Shf Frt	206
Rr O/P Shf Rr	BH1810
Dr. Sprocket (2 Pcs)	HK5020
Ndl Thrust Brg	NTA3244
Ndl Thrust Washer	TRC3244
<i>Sealant & Small Parts Kits</i>	
Deluxe Kit	SK207
Basic Kit	K100907
Shift Fork Insert Set	SFI-207
Small Parts Kit	SP207-50

207 Sealant Kits	
SK 207	
K100907	
Input Seal	4269183
Frt O/P Seal	15514
Rear O/P Seal	96135
Oil Pump Hgs Seal	22306B
Adpt Gasket	33706
Spline Washer	15578
O-Ring Set	207-OK
Ultra Black 598	22072

231, 231C Sealant Kits	
SK 231	
K100907C	
Input Seal	4269183
Frt O/P Seal	15514
Rear O/P Seal, Chrysler	15546
Rear O/P Seal	18992
Rear O/P Seal	96135
Oil Pump Hgs Seal	22306B
Adpt Gasket	33706
Spline Washer	15578
O-Ring Set	207-OK
Ultra Black 598	22072

OE Borg Warner 207/231 Chains	
1/2 P X 1-1/4 W X 62 Links	HV022
1/2 P X 1.00 W X 62 Links	HV027

207/231 Universal Small Parts Kits	
SP207-50	
SP 207-50A	
Ndl Thrust Washer	TRC3244
Ndl Thrust Brg	NTA3244
Thrust Washer Set	207-WS
Snap Ring Set	207-SRS
Shift Fork Insert Set	SFI-207
Spline Washer	15578
O-Ring Set	207-OK
Ext Housing Bush	266-62
Plug	4167938

207/231 Universal Shift Fork Inserts Set	
SFI-207	
Insert	14037965
Inserts (4 Pcs)	14037966
Insert	14070291

New Process Master and Bearing Kits



231-HD- Jeep 231-C-GM
Double Row Ball Brg Input with or
w/o Welsh Plug 1987-1996/97

233 or 231
Single or Double Row Ball Brg Input
1996 & After

TCM231-HD		<i>Jeep Univ</i>	▼
TC231-HD:		<i>Jeep Univ</i>	▼
TCM231-C		<i>GM Univ</i>	▼
TC231-C:			▼
<i>Major Bearing Group</i>			
Input	BD508	◆	◆
Frt O/P Shf Frt	206	◆	◆
Frt O/P Shf Rr	SCE2416	◆	◆
Rr O/P Shf Frt	206	◆	◆
Rr O/P Shf Rr	BH1810	◆	◆
Rr O/P Shf Rr	83503507	◆	◆
Dr. Sprocket	HK5020-2	◆	◆
Ndl Thrust Brg	NTA3244	◆	◆
Ndl Thrust Washer	TRC3244	◆	◆
<i>Sealant & Small Parts Group</i>			
<i>Deluxe Kit</i>	SK231	◆	◆
<i>SF Insert Set</i>	SF1-207	◆	◆
<i>Small Part Kit</i>	SP207-50A	◆	◆

TCM231/3-HD			▼
TC231/3-HD			▼
TCM233			▼
TC233:			▼
<i>Major Bearing Group</i>			
Input	BD508	◆	◆
Input-Late (231)	110-L	◆	◆
Frt O/P Shf Frt	206	◆	◆
Frt O/P Shf Rr	SCE2416	◆	◆
Rr O/P Shf Frt	206	◆	◆
Rr O/P Shf Rr	BH1810	◆	◆
Rr O/P Shf Rr	83503507	◆	◆
Dr. Sprocket (2 Pcs)	HK5020	◆	◆
Ndl Thrust Brg	NTA3244	◆	◆
<i>Sealant & Small Parts Group</i>			
<i>Ultra Black 598</i>	22072	◆	◆
<i>Deluxe Kit</i>	SK231	◆	◆
<i>Basic Kit</i>	K100907	◆	◆
<i>SF Insert Set</i>	SF1-207	◆	◆
<i>Small Part Kit</i>	SP207-50A	◆	◆

231 Chain	
OE Borg Warner	
1/2 P X 1-1/4 W X 62 Links	HV022
1/2 P X 1.00 W X 62 Links	HV027





New Process Master, Bearing and other Kit Content Drawings

NP 241 All Popular Versions

241 Universal Design Use 241-U
NP 241 1992 & Before
with Double Row Ball Brg Input

241 Dodge 1994 & After w Diesel
use 241-DHD

NP 241 Dodge 93 & After
Single Row Ball Brg Input use 241-A

TC241-U	
TC241:	
BK 241	
BK 241-W1	
<i>Major Bearing Group</i>	
Input	110-L
Input	BD508
Frnt O/P Shf Frt	207
Frnt O/P Shf Rr	SCE2416
Rr O/P Shf Frt	207
Rr O/P Shf Rr	BH1810
Rr O/P Shf Rr	83503507
Rr O/P Shf Rr	B2110
Dr. Sprocket	HK5020-2
<i>Sealant & Small Parts Kits</i>	
Deluxe Sealant Kit	SK241
Basic Sealant Kit	K100908A
Basic Seal & Gskt Set	K100908B
SF Insert Set	SFI-241

TC241-DHD	
TC241-A	
BK 241-A	
<i>Major Bearing Group</i>	
Input	110-L
Frnt O/P Shf Frt	207-L0
Frnt O/P Shf Rr	SCE2416
Rr O/P Shf Frt	207-L0
Rr O/P Shf Frt	BB1-1015
Rr O/P Shf Rr	B2110
Rr O/P Shf Rr	BH1810
Dr. Sprocket	HK5020-2
Dr. Sprocket	SCE3612
<i>Oil Seals & Small Parts Kits</i>	
Input	4269183
Frnt O/P	18992
Frnt O/P	18173
Rear O/P	18662
Rear O/P	15546
Oil Pump Hgs Seal	22306B
Adpt Gasket	35854
Spline Washer	611689
SF Insert Set	SFI-241
O-Ring Set	241-OK
Ultra Black 598	22072
SK241-AXJ	

241 Sealant Kits	
SK 241- AXJ	
SK 241:	
K100908A	
K100908B:	
Input Seal	4269183
Frnt O/P Seal	18662
Frnt O/P Seal	15546
Rr O/P Seal	18992
Oil Pump Hgs Seal	22306A
Adapter Gasket	35854
Spline Washer	611689
O-Ring Set	241-OK
Ultra Black 598	22072
Shift Fork Insert Set	SFI-241

241 Shift Fork Insert Set	
SFI-241	
Insert	14037965
Inserts (4 Pcs)	14037966
Insert	14070291
Insert	14095680

OE Borg Warner 241 Chain:	
1/2 P X 1-1/4 W X 72 Links	HV014
1/2 P X 1-1/4 W X 72 Links	HV025
1/2 P X 1-1/2 W X 72 Links	HV031

New Process Master, Bearing
and other Kit Content Drawings



NP 242
Universal

New Venture
243

TC 242	
BK 242:	
<i>Major Bearing Group</i>	
Input	BD508
Frt O/P Shf Frt	207
Frt O/P Shf Rr	SCE2416
Rr O/P Shf Frt	206
Rr O/P Shf Rr	83503507
Sprocket Ndl Set	Q8308-53
<i>Seal & Small Parts Kits</i>	
Deluxe Sealant Kit.	SK242
Basic Sealant Kit	SK242-X
Shift Fork Insert Set	SFI-241

TC 243	
<i>Major Bearing Group</i>	
Input	110-L
Frt O/P Shf Frt	207
Frt O/P Shf Rr	SCE2416
Rr O/P Shf Frt	207
Rr O/P Shf Rr	83503507
Sprocket Ndl Set	Q8308-53
<i>Shift Fork Insert Group</i>	
Insert	14037965
Insert	14070291
Inserts (4 Pcs)	996969
<i>Oil Seal Group</i>	
Input	4269183
Frt O/P	18662
Rear O/P	18992
Oil Pump Hgs Seal	22306B
<i>Paper, Rubber, Small Parts Group</i>	
Adapter Gasket	35854
Spline Washer	611689
O-Ring Set	243-OK
SK 243	

New Venture 242 Sealant Kits	
SK 242	
SK 242-X:	
K 100918	
Input	4269183
Frt O/P	18647
Rear O/P	9613S
Oil Pump Hgs Seal	22306B
O-Ring Set	242-OK
Ultra Black 598	22072
RTV	10250

243 Chain	
OE Borg Warner	
1/2 PX 1-1/4 W X 72 Links	HV025

242 Chain:	
OE Borg Warner	
1/2 PX 1.00 W X 72 Links	HV028
1/2 PX 1-1/2 W X 72 Links	HV031





New Process Master, Bearing
and other Kit Component Drawings

NP 249 Jeep 1992 & After
Assemblies 52097529, 52097530,
52098667, & 52098682

NP 249 Jeep 1994 & After
Assemblies 52098267, 52098532
& 52097539

TC 249	
<i>Major Bearing Group</i>	
Input	BD508
Frt O/P Shf Frt	207
Frt O/P Shf Rr	SCE2416
Rr O/P Shf Frt	206
Pilot Ndl Set	Q8309-53
Dr. Sprocket	HK5020-2
<i>Shift Fork Insert Group</i>	
Inserts (2 Pcs)	14037966
Insert	14095680
<i>Oil Seal Group</i>	
Input	4269183
Frt O/P	18662
Rear O/P	76925
Oil Pump Hgs Seal	22306B
O-Ring	AS109
SK 249	

TC249-JA	
<i>Major Bearing Group</i>	
Input	110-L
Frt O/P Shf Frt	207
Frt O/P Shf Rr	SCE2416
Rr O/P Shf Frt	206
Rr O/P Shf Rr	Q8309-53
Pilot Ndl Set	Q8309-53
Dr. Sprocket	HK5020-2
<i>Shift Fork Insert Group</i>	
Insert Set	14037966-2
Insert	14095680
<i>Oil Seal Group</i>	
Input	4269183
Frt O/P	18662
Rear O/P	96135
Oil Pump Hgs Seal	22306B
O-Ring	AS116
SK 249	

OE Borg-Warner	
249 Chain	
3/8 PX 1-1/4 WX 98 Links	HV034

New Process Transfer Case Kit Recap Sheet



Kit: Number	▼
BK202-NP	41
BK203	42
BK203-F	43
BK203-G	43
BK205	46
BK205-4GDM	45
BK205-D	44
BK205-FDM	45
BK207	48
BK208	47
BK228/9-X	47
BK231	48
BK241	50
BK241-A	50
BK241-W1	50
BK242	51
K100900	43
K100900F	43
K100900U	42
K100901	45
K100906	47
K100907	48
K100907C	48
K100908	47
K100908A	50
K100908B	50
K100918	51
K100924G	45
K100957	45
K100957	46
SK200	41
SK203-F	43
SK203-FX	43
SK203-G	43
SK203-GX	43
SK203-U	42
SK205	46
SK205-4GDM	45
SK205-D	44
SK205-DFG	46
SK205-FDM	45
SK205-GDM	45
SK205-UDM	44
SK207	48
SK208-XJ	47
SK228/9	47
SK231	48
SK241	50
SK241-AXJ	50
SK242	51

Kit: Number	▼
SK242-X	51
SK243	51
SK249	52
SP203-50	42
SP203-50A	42
SP203-50N	42
SP205-50	44
SP205-50	46
SP205-50A	44
SP205-50N	44
SP207-50	48
SP207-50A	48
SP228/9-50	47
TC200	41
TC203-F	43
TC203-FX	43
TC203-G	43
TC203-GX	43
TC203-U	42
TC203-XA	42
TC205	46
TC205-4GDM	45
TC205-D	44
TC205-DFG	46
TC205-FDM	45
TC205-GDM	45
TC205-UDM	44
TC207	48
TC208-XJ	47
TC228/9	47
TC231	48
TC231-C	49
TC231-HD	49
TC231/3-HD	49
TC233	49
TC241	50
TC241-A	50
TC241-DHD	50
TC241-U	50
TC242	51
TC243	51
TC249	52
TC249-JA	52
TCM203-F	43
TCM203-G	43
TCM203-U	42
TCM205	46
TCM205-D	44
TCM205-DFG	46
TCM205-FDM	45

Kit: Number	▼
TCM205-GDM	45
TCM205-UDM	44
TCM207	48
TCM208-XJ	47
TCM228/9	47
TCM231	48
TCM231-C	49
TCM231-HD	49
TCM231/3-HD	49
TCM233	49

Rockwell
Medium Truck Applications
GM & International
On Road & Off Road

Rockwell Bearing Kit Component Drawings



Rockwell made for International Int/Navistar TC143	
TC143	
<i>Major Bearing Group</i>	
Input Frt	207
Input Rr	207
Output Frt	306
Output Rr	MJH20161
<i>Oil Seal Group</i>	
Input Seal	19886
Frt Output Seal	16406
Rr Output Seal	16406

Rockwell T223C	
TC223-C	
<i>Major Bearing Group</i>	
Input Frt Tpr Set	332-339
Input Rr Tpr Set	372-376
Lower Output Frt	1211-L
Lower Output Rr	208-L
Upper Output Frt	25821-78
Upper Output Rr	25520-84
Idler Gear Frt	31521-97
Idler Gear Rr	31521-97
<i>Sealant Group</i>	
Oil Seal	21100
Oil Seal	21136
Oil Seal	22340
Oil Seal	26190
Shift Shft Seal Set	7443-2
SK223-C	

Rockwell T221 GM	
TC221-GXJ	
<i>Major Bearing Group</i>	
Input Frt	209-L
Input Rr	207-L
Output Frt	206-L
Output Rr	207-L
Idl Frt Tpr Brg Set	02420-76
Idl Frt Tpr Cone	15126
Idl Frt Tpr Cup	15245
Idl Rr Tpr Cone	15126
Idl Rr Tpr Cup	15245
<i>Sealant Group</i>	
Input Seal	17386
Output Seal Set	17386-2
Output Seal Set	19760-2
Shift Shft Seal Set	7443-2
Rockwell Gasket & Shim Set	479-55
SK221	

Rockwell T223H Taper Roller Bearing Design	
TC223-H	
<i>Major Bearing Group</i>	
Input Frt Tpr Set	332-339
Input Rr Tpr Set	372-376
Lower Output Frt	1211-L
Lower Output Rr	208-L
Upper Output Frt	25821-78
Upper Output Rr	25520-84
Idler Gear Frt	31521-97
Idler Gear Rr	89411-49
<i>Sealant Group</i>	
Oil Seal	21100
Oil Seal	22340
Oil Seal	22340
Oil Seal	26190
Shift Shft Seal Set	7443-2
SK223-C	

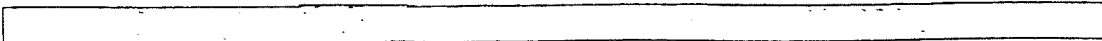



Rockwell Bearing Kit Component Drawings

Rockwell T223H Ball Bearing Design	
TC167	
<i>Major Bearing Group</i>	
Input Frt	309-S
Input Rr	307-S
Lower Output Frt	211-L
Lower Output Rr	208-L
Upper Output Frt	25821-78
Upper Output Rr	25520-84
Idler Gear Frt	31521-97
Idler Gear Rr	89411-49
<i>Sealant Group</i>	
Oil Seal	21100
Oil Seal	22340
Oil Seal	22340
Oil Seal	26190
Shift Shft Seal Set	7443-2
SK223-C	

Rockwell T226-L	
TC226-31	
<i>Major Bearing Group</i>	
Ball Brg	1209
Ball Brg	1209
Tpr Set	807010-46
Tpr Set	3732-3782
Tpr Set	45220-45287
Tpr	59201
Tpr	59412
Tpr	33225
Tpr	33472
Tpr	59200
Tpr	59412
Declutch Shft	382A-385A
Declutch Shft	382A-385A
<i>Sealant Group</i>	
Oil Seal	29317
Oil Seal	29317
Oil Seal	29317
Shift Shft Seal	8627
Shift Shft Seal	7414
SK226	

Rockwell T226-31	
TC226-31	
<i>Major Bearing Group</i>	
Ball Brg	1209
Ball Brg	1209
Inter Shft Tpr Set	3732-3767
Inter Shft Tpr Set	3732-3782
Lower Output Frt	59200
Lower Output Rr	59412
Lower Output Rr	59200
Lower Output Frt	59412
Upper Output Frt	33225
Upper Output Frt	33475
Upper Output Rr	59200
Upper Output Rr	59412
Declutch Shft	382A-385A
Declutch Shft	382A-385A
<i>Sealant Group</i>	
Oil Seal	29317
Oil Seal	29317
Oil Seal	29317
Shift Shft Seal	8627
Shift Shft Seal	7414
SK226	

Rockwell Transfer Case Kit Recap Sheet



Kit Number	More Information See Page	▼
TC221-GXJ		55
TC223-C		55
TC223-H	Taper Design	55
TC167	Ball Design	56
TC226-L		56
TC226-31		56



Section III

Sealant & Small Parts Kits, Sets & Assemblies

Borg-Warner **Page 59-60**

Dana **Page 61**

New Process **Page 62-63**

Transfer Case Adapter Gaskets

Page 64 & 65

Transfer Case Kit Interchange

Page 66-67



Borg Warner Sealant and Small Parts Kit Sets, Assemblies and Parts

Parts Drawing See Page- ▼	
13-05 Jeep Quadratrac 1973-80	22
<i>Deluxe Sealant Kit</i>	SK 1305
<i>Chain</i>	HV 007
<i>Chain for Units with Zero Red.</i>	HV 007X

Parts Drawing See Page ▼	
13-59 Ford, Bronco II & Ranger 4 X 2 1987-89	25
<i>Deluxe Sealant Kit</i>	SK 1359
<i>Basic Sealant Kit</i>	K1 00959

Parts Drawing See Page- ▼	
13-45 Part Time Ford, Bronco & Truck 1981-86	22
<i>Deluxe Sealant Kit</i>	SK 1345-XJ
<i>OE Sealant Kit</i>	SK 1345
<i>Original Sealant Kit Design</i>	SK 1345-X
<i>Basic Sealant Kit</i>	K1 00909
<i>Adapter Gasket</i>	36086
<i>Chain</i>	HV 012
<i>Chain</i>	HV 013
<i>Pump Overhaul Kit</i>	PK 1345
<i>Shift Fork Insert Set</i>	SFI-1345
<i>Major Small Parts Kit</i>	SP 1345-50
<i>Small Parts-Kit Replacement</i>	SP 1345-50A

Parts Drawing See Page ▼	
13-70 Part Time Electric or Manual	24
<i>Deluxe Sealant Kit Man & Elec</i>	SK 1356-XJ
<i>Deluxe Sealant Kit Man</i>	SK 1356
<i>OE Sealant Kit</i>	SK 1356
<i>Original Sealant Kit Design</i>	SK 1356-X
<i>Basic Sealant Kit</i>	K1 00919
<i>Adapter Gasket 5 Pc/Pkg</i>	E7TZ7086A-5
<i>Chain</i>	HV 012
<i>Chain</i>	HV 014
<i>Chain</i>	HV 025
<i>Pump Overhaul Kit</i>	PK 1356
<i>Shift Fork Insert Set</i>	SFI-1356
<i>Major Small Parts Kit</i>	SP 1356-50
<i>Small Parts-Kit Replacement</i>	SP 1356-50A

Parts Drawing See Page- ▼	
13-50 - 54 Part Time Ford, Bronco II & Ranger 1981-93 Electric or Manual	23
<i>13-50 Deluxe Sealant Kit</i>	SK 1350
<i>13-54 Deluxe Sealant Kit</i>	SK 1354
<i>13-50 Basic Sealant Kit</i>	K1 00910
<i>13-54 Basic Sealant Kit</i>	K1 00912
<i>Chain</i>	HV 022
<i>Pump Overhaul Kit</i>	PK 1350

Parts Drawing See Page ▼	
13-72 GM Astro, Bravada, or Safari 1988 & After	25
<i>Deluxe Sealant Kit</i>	SK 1372-XJ
<i>Basic Sealant Kit</i>	K1 00972
<i>Chain</i>	HV 032
<i>Chain</i>	HV 033
<i>Major Small Parts Kit</i>	SP 1372-50
<i>Small Parts-Kit Replacement</i>	SP 1372-50A

Parts Drawing See Page: ▼	
13-56 Part Time Electric or Manual	24
<i>Deluxe Sealant Kit Man & Elec</i>	SK 1356-XJ
<i>Deluxe Sealant Kit Man</i>	SK 1356
<i>OE Sealant Kit</i>	SK 1356
<i>Original Sealant Kit Design</i>	SK 1356-X
<i>Basic Sealant Kit</i>	K1 00919
<i>Adapter Gasket 5 Pc/Pkg</i>	E7TZ7086A-5
<i>Chain</i>	HV 012
<i>Chain</i>	HV 014
<i>Chain</i>	HV 025
<i>Pump Overhaul Kit</i>	PK 1356
<i>Shift Fork Insert Set</i>	SFI-1356
<i>Major Small Parts Kit</i>	SP 1356-50
<i>Small Parts-Kit Replacement</i>	SP 1356-50A

Parts Drawing See Page ▼	
44-01 GM 1988 & After w/Extension Housing No. 15 63 167	26
<i>Deluxe Sealant Kit</i>	SK 4401
<i>Chain</i>	HV 025
<i>Chain</i>	HV 027

Parts Drawing See Page- ▼	
44-04 Ford 1995 & After	26
<i>Deluxe Sealant Kit</i>	SK 4401
<i>Chain</i>	HV 051



Borg Warner Sealant and Small Parts Kit Sets, Assemblies and Parts

Parts Drawing See Page-		▼
44-05 Ford Explorer		26
Electric or Manual 1995 & After		
<i>Deluxe Sealant Kit</i>	SK 4405	
<i>Chain</i>	HV 051	
<i>Major Small Parts Kit</i>	SP 4405-50	
<i>Small Parts-Kit Replacement</i>	SP 4405-50 A	

Parts Drawing See Page-		▼
44-72 GM 1988 & After		25
<i>Deluxe Sealant Kit</i>	SK 1372-XJ	
<i>Basic Sealant Kit</i>	K 1 0097 2	
<i>Chain</i>	HV 032	
<i>Chain</i>	HV 033	
<i>Major Small Parts Kit</i>	SP 1372-50	
<i>Small Parts-Kit Replacement</i>	SP 1372-50 A	

Parts Drawing See Page-		▼
44-06 Ford Bronco & Expedition		27
Electric & manual with Torque on Demand		
<i>Deluxe Sealant Kit</i>	SK 4406-T O D	
<i>Chain</i>	HV 052	
<i>Chain</i>	HV 053	
<i>Small Parts-Kit Replacement</i>	SP 4405-50 A	

Parts Drawing See Page-		▼
44-06 Ford Full Size Truck		27
Electric & manual without Torque on Demand		
<i>Deluxe Sealant Kit</i>	SK 4406-W O	
<i>Chain</i>	HV 052	
<i>Chain</i>	HV 053	
<i>Small Parts-Kit Replacement</i>	SP 4405-50 B	

Parts Drawing See Page-		▼
44-07 Ford F250, 350 Truck		28
1995 & After		
<i>Deluxe Sealant Kit</i>	SK 4407	
<i>Chain</i>	HV 054	

Parts Drawing See Page-		▼
44-70 GM 1989 & After		28
<i>Deluxe Sealant Kit</i>	SK 4470	
<i>Chain</i>	HV 050	



Dana Sealant and Small Parts Kit Sets, Assemblies and Parts

Parts Drawing See Page: ▼	
Dana Model 18 Jeep, International	32
<i>Deluxe Sealant Kit</i>	SK 18
<i>Basic Sealant Kit</i>	K 1 0091 4
<i>Major Small Parts Kit</i>	SP 18-50B

Parts Drawing See Page: ▼	
Dana Model 20 Jeep, International	32
<i>Deluxe Sealant Kit</i>	SK 20
<i>Basic Sealant Kit</i>	K 1 0091 5
<i>Major Small Parts Kit</i>	SP 20-50

Parts Drawing See Page: ▼	
Dana Model 20 Ford	33
<i>Deluxe Sealant Kit</i>	SK 20-F
<i>Major Small Parts Kit</i>	SP 20-50

Parts Drawing See Page: ▼	
Dana Model 21 Ford	34
<i>Deluxe Sealant Kit</i>	SK 21-F

Parts Drawing See Page: ▼	
Dana Model 23, 24 Ford	34
<i>Deluxe Sealant Kit</i>	SK 24

Dana Model 28 Ford	35
<i>Deluxe Sealant Kit</i> <i>Chain</i>	SK 28-F HV 048

Parts Drawing See Page: ▼	
Dana Model 300 Jeep, International	35
<i>Deluxe Sealant Kit</i>	SK 300
<i>Basic Sealant Kit</i>	K 1 0091 6
<i>Major Small Parts Kit</i>	SP 300-50



New Process/New Venture Sealant and Small Parts Kit Sets, Assemblies and Parts

Parts Drawing See Page: ▼	
NP 200, 201, 202	41
<i>Deluxe Sealant Kit</i>	SK 200

Parts Drawing See Page: ▼	
NP 203 Universal Kits	42
<i>Deluxe Sealant Kit</i>	SK 203- U
<i>Basic Sealant Kit</i>	K 1 0090 0U
<i>Chain</i>	HV 005
<i>Chain</i>	HV 009
<i>Major Small Parts Kit</i>	SP 203- 50
<i>Small Parts-Kit Replacement</i>	SP 203- 50A
<i>Needle Set Replacement</i>	SP 203- 50N

Parts Drawing See Page: ▼	
NP 203 Ford	43
<i>Popular Ford</i>	SK 203- F
<i>Deluxe Sealant Kit</i>	
<i>F250 1974-76 Only</i>	SK 203- FX
<i>Deluxe Sealant Kit</i>	
<i>Basic Sealant Kit</i>	K 1 0090 0F

Parts Drawing See Page: ▼	
NP 203 GM & Dodge	43
<i>Popular GM & Dodge</i>	SK 203- G
<i>Deluxe Sealant Kit</i>	
<i>GM Early with Cast Iron Tail</i>	SK 203- GX
<i>Only Deluxe Sealant Kit</i>	
<i>Basic Sealant Kit</i>	K 1 0090 0

Parts Drawing See Page: ▼	
NP 205 Direct Mount Universal Popular Dodge, Ford, & GM	44
<i>Deluxe Sealant Kit</i>	SK 205- UDM
<i>Major Small Parts Kit</i>	SP 205- 50
<i>Small Parts-Kit Replacement</i>	SP 205- 50A
<i>Needle Set Replacement</i>	SP 205- 50N

Parts Drawing See Page: ▼	
NP 205 Dodge Direct Mount 1987 & Before	45
<i>Deluxe Sealant Kit</i>	SK 205- GDM
<i>Basic Sealant Kit</i>	K 1 0090 1

Parts Drawing See Page: ▼	
NP 205 Dodge Direct Mount 1988 & After	44
<i>Deluxe Sealant Kit</i>	SK 205- D
<i>Basic Sealant Kit</i>	K 1 0095 9

Parts Drawing See Page: ▼	
NP 205 Ford Direct Mount	45
<i>Deluxe Sealant Kit</i>	SK 205- FDM
<i>Basic Sealant Kit</i>	K 1 0095 7

Parts Drawing See Page: ▼	
NP 205 GM 350 Direct Mount	45
<i>Deluxe Sealant Kit</i>	SK 205- GDM
<i>Basic Sealant Kit</i>	K 1 0090 1

Parts Drawing See Page: ▼	
NP 205 GM 400 Direct Mount	45
<i>Deluxe Sealant Kit</i>	SK 205- 4GDM
<i>Basic Sealant Kit</i>	K 1 0092 4G

Parts Drawing See Page: ▼	
205 Ford Remote Mount Midship	46
<i>Deluxe Sealant Kit</i>	SK 205
<i>Basic Sealant Kit</i>	K 1 0094 7

Parts Drawing See Page: ▼	
205 Universal Remote Mount Ford, Dodge & GM	46
<i>Deluxe Sealant Kit</i>	SK 205- DFG

Parts Drawing See Page: ▼	
NP 207 Universal	48
<i>Deluxe Sealant Kit</i>	SK 207
<i>Basic Sealant Kit</i>	K 1 0090 7
<i>Chain</i>	HV 022
<i>Chain</i>	HV 027
<i>Shift Fork Insert Set</i>	SFI-207
<i>Major Small Parts Kit</i>	SP 207- 50
<i>Small Parts-Kit Replacement</i>	SP 207- 50A



**New Process/New Venture Sealant and Small Parts Kit
Sets, Assemblies and Parts**

Parts Drawing See Page: ▼	
208 Universal	47
<i>Deluxe Sealant Kit</i>	SK 208- XJ
<i>Basic Sealant Kit</i>	K 1 00908
<i>Chain</i>	HV 012
<i>Chain</i>	HV 014
<i>Chain</i>	HV 015
<i>Shift Fork Insert Set</i>	SFI-208
<i>Major Small Parts Kit</i>	SP 208- 50
<i>Small Parts-Kit Replacement</i>	SP 208- 50A
<i>Ring Gear Bushing</i>	41 67958

Parts Drawing See Page: ▼	
241 Series	50
<i>Deluxe Sealant Kit</i>	SK 241
<i>Basic Sealant Kit</i>	K 1 00908A
<i>Basic Seal & Gasket Set</i>	K 1 00908B
<i>Chain</i>	HV 014
<i>Chain</i>	HV 025
<i>Chain</i>	HV 031
<i>Shift Fork Insert Set</i>	SFI-241

Parts Drawing See Page: ▼	
229, 228 Series Jeep with & w/o Viscous Coupler	47
<i>Deluxe Sealant Kit</i>	SK 228/9
<i>Original Design</i>	SK 228/9-X
<i>Basic Sealant Kit</i>	K 1 00906
<i>Chain</i>	HV 012
<i>Chain</i>	HV 014
<i>Chain</i>	HV 015
<i>Shift Fork Insert Set</i>	SFI-228/9
<i>Major Small Parts Kit</i>	SP 228/9-50
<i>Small Parts-Kit Replacement</i>	SP 228/9-50A

Parts Drawing See Page: ▼	
242 Jeep	51
<i>Deluxe Sealant Kit</i>	SK 242
<i>Original Design</i>	SK 242- X
<i>Basic Seal & Gasket Set</i>	K 1 00918
<i>Chain</i>	HV 028
<i>Chain</i>	HV 031
<i>Shift Fork Insert Set</i>	SFI-241

Parts Drawing See Page: ▼	
231 Series	48 49
<i>Deluxe Sealant Kit</i>	SK 207
<i>Deluxe Sealant Kit</i>	SK 231
<i>Basic Sealant Kit</i>	K 1 00907
<i>Basic Sealant Kit</i>	K 1 00907C
<i>Chain</i>	HV 022
<i>Chain</i>	HV 027
<i>Shift Fork Insert Set</i>	SFI-207
<i>Major Small Parts Kit</i>	SP 207- 50
<i>Small Parts-Kit Replacement</i>	SP 207- 50B

Parts Drawing See Page: ▼	
New Venture 243	51
<i>Deluxe Sealant Kit</i>	SK 243
<i>Chain</i>	HV 025

Parts Drawing See Page: ▼	
249 Series Jeep	52
<i>Deluxe Sealant Kit</i>	SK 249
<i>Chain</i>	HV 034



Transfer Case Adapter Gaskets

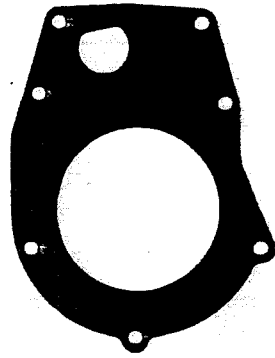

35844

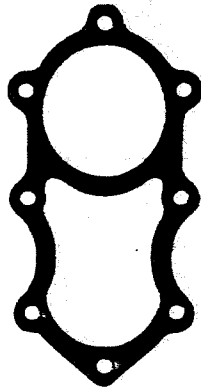

3586A



35866

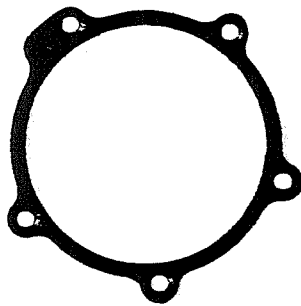

33706

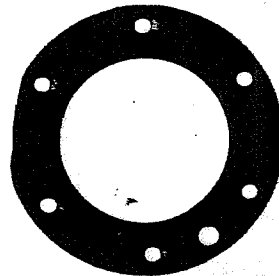

36086
E7TZ-7120B

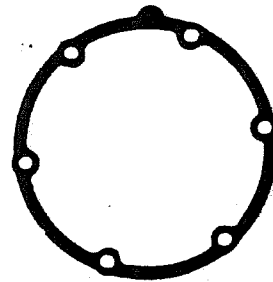

35854

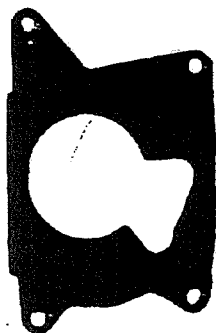

1305147

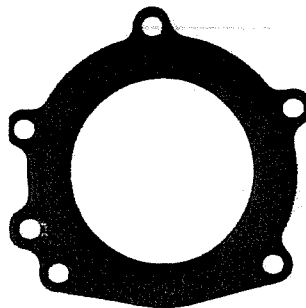

G1350

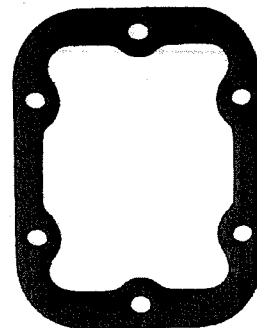

6067-X



Transfer Case Adapter Gaskets

Part Number & Application	10 Qty Package Part No.	25 Qty Package Part No.	50 Qty Package Part No.
35844			
GM 1973-80 & Dodge 1974-80 with New Process 203	35844-10		
35866			
Ford & Dodge 1969 & After with New Process 205	35866-10		
35866A			
GM with TH400 Automatic & Large Dia. Bearing Retainer: 1969-86 with New Process 205	35866A-10		
33706			
GM, Dodge, Jeep with New Process 207	33706-10	33706-25	33706-50
36086			
Ford with Warner 13-45, 13-56 & New Process 208	36086-10	36086-25	36086-50
35854			
Popular New Process	35854-10	35854-25	35854-50
1305147			
Jeep with B-W 13-05 Quadtrac	1305147-10		
G1350			
B-W 13-50 & 13-54	G1350-10	G1350-25	G1350-50
6067-X			
Chelsea/Muncie PTO Gasket	6067-X10	6067-X25	6067-X50



Transfer Case Kit Interchange by Competitive Kit Number

203-50	MWT	SP203-50
205-50	MWT	SP205-50
208-50	MWT	SP208-50A
420412X	Dana	TC420412-X
420482X	Dana	TC420482-X
420483X	Dana	TC420483-X
BK1305	ATP	TC1305-B
BK1345	ATP	BK1345
BK1350	ATP	BK1350X
BK1354	ATP	BK1354
BK1356	ATP	BK1356
BK1359	ATP	BK1359
BK1372	ATP	BK1372
BK18	ATP	BK18
BK20	ATP	BK20
BK200/1	ATP	TC200
BK203F	ATP	BK203F
BK203FD	ATP	TC203-E
BK203G	ATP	BK203G
BK203G1	ATP	BK203GX
BK205D	ATP	BK205D
BK205FDM	ATP	BK205FD
BK205GDM	ATP	TC205-GDM
BK205GDM4	ATP	TC205-4GDM
BK205RDF	ATP	BK205M
BK207	ATP	BK207
BK208	ATP	BK208
BK20FB	ATP	BK20FB
BK20FE	ATP	BK20F
BK21	ATP	BK21
BK221	ATP	BK221
BK226	ATP	TC218-XH
BK228	ATP	BK228/9X
BK230	ATP	BK233C
BK231	ATP	TC231
BK231-A	ATP	TC233
BK231J	ATP	TC231
BK24	ATP	BK24
BK241	ATP	BK241
BK241A	ATP	BK241A
BK242	ATP	BK242
BK249J	ATP	TC249
BK249JA	ATP	TC249-JA
BK300	ATP	BK300
BK332	ATP	TC243
BK349	ATP	TC218-XH
BK369	ATP	BK28
BK4404	ATP	BK4404
BK4405	ATP	BK4405
BK4406	ATP	BK4406
BK4407	ATP	TC4407
BW1345BK	Perf	TC1345
BW1350BK	Perf	TC1350
BW1354BK	Perf	TC1354
BW1356BK	Perf	TC1356
BW4404BK	Perf	TC4404

BW4405BK	Perf	TC4405
BW4406BK	Perf	TC4406-WO
BW4407BK	Perf	TC4407
BW4470BK	Perf	TC4470
DTK-1345	DT	SK1345
DTK-1356	DT	SK1356
DTK-203	DT	SK203-Q
DTK-205	DT	SK205-GDM
DTK-207	DT	SK207
DTK-208	DT	SK208
GS1345	Perf	SK1345
GS1350E	Perf	SK1350
GS1350M	Perf	SK1350-X
GS1354	Perf	SK1354-X
GS1356	Perf	SK1356
GS1754	Perf	SK1354
GS1756E	Perf	SK1356-XJ
GS1756M	Perf	SK1356
GS203	Perf	SK203-G
GS203F	Perf	SK203-F
GS205	Perf	SK205-4GDM
GS205D	Perf	SK205
GS205F	Perf	SK205-FDM
GS205G	Perf	SK205-GDM
GS205T	Perf	SK205-GDM
GS207	Perf	SK207
GS208	Perf	SK208
GS228/9	Perf	SK228/9
GS242	Perf	SK242
GS4404	Perf	SK4404
GS4405	Perf	SK4405
GS4406	Perf	SK4406-WO
GS4407	Perf	SK4407
GS4470	Perf	SK4470
K100900	Ace	K100900
K100901	Ace	K100901
K100903	Ace	SK1305
K100905	Ace	K100905
K100906	Ace	K100906
K100908	Ace	K100908
K100909	Ace	K100909
K100910	Ace	K100910
K100912	Ace	K100912
K100913	Ace	SK228/9
K100914	Ace	K100914
K100915	Ace	K100915
K100916	Ace	K100916
K100917	Ace	K100917
K100918	Ace	K100918
K100919	Ace	K100919
K100920	Ace	BK231
K100921	Ace	BK241
K100922	Ace	BK242
K100926	Ace	TC249-JA
K100930	Ace	SK4470

K100935	Ace	TC249
K100971	Ace	TC233
K100972	Ace	TC233
K100973	Ace	TC233
K100974	Ace	TC231/3
K100975	Ace	TC241-A
K100978	Ace	BK4405
K100980	Ace	BK203G
K100981	Ace	BK203F
K100982	Ace	TC205GDM
K100983	Ace	BK205FDM
K100984	Ace	BK1372
K100985	Ace	BK208
K100985BK	Ace	TC208-XJ
K100986	Ace	TC208-XJ
K100986BK	Ace	TC208-XJ
K100987	Ace	BK207
K100988	Ace	BK1345
K100989	Ace	BK1350-X
K100990	Ace	BK228/9X
K100990BK	Ace	TC228/9
K100991	Ace	TC228
K100992	Ace	BK1356
K100993	Ace	TC1356
K100994	Ace	BK4470
K100997	Ace	BK1354
K100998	Ace	BK28
K1305	MWT	SK1305
K1345	MWT	K100909
K1350	MWT	K100910
K1356	MWT	K100919
K18	MWT	K100914
K20	MWT	K100915
K203	MWT	K100900
K203A	MWT	SK203-F
K205	MWT	K100901
K207	MWT	K100907
K231	MWT	K100907A
K242	MWT	K100918
K300	MWT	K100916
MK105900	T.S.	BK203
MK105901	T.S.	TC205-GDM
MK105903	T.S.	TC1305-B
MK105907	T.S.	TC207
MK105907A	T.S.	TC231
MK105908	T.S.	TC208-XJ
MK105908A	T.S.	TC241
MK105909	T.S.	TC1345
MK105910	T.S.	BK1350
MK105912	T.S.	TC228/9
MK105913	T.S.	TC228/9
MK105914	T.S.	TC242
MK105919	T.S.	TC20
MK105919	T.S.	TC1356
NP203BK	Perf	TC203-G
NP203FBK	Perf	TC203-F

Ace is Ace-O-Matic, ATP is All Transmission Parts,
DT Is DT Components/North Coast Bearings, F-M is Federal Mogul,
MWT is Midwest Truck/Motive Gear, Perf is Perfection Hy-Test



Transfer Case Kit Interchange by Competitive Kit Number

NP203RBK	Perf	TC203-F
NP203TBK	Perf	TC203-Q
NP205BK	Perf	TC205-4QDM
NP205D	Perf	TC205
NP207BK	Perf	TC207
NP208BK	Perf	BK208
NP228/9BK	Perf	BK228/9
NP231BK	Perf	BK231
NP231JBK	Perf	TC231/3
NP231LBK	Perf	TC233
NP241BK	Perf	TC241
NP241DBK	Perf	TC241-A
NP242BK	Perf	TC242
T-161	F-M	TC18
T-165	F-M	BK202-NP
T-166A	F-M	TC20
T-172	F-M	TC205-QDM
T-172FG	F-M	TC205-FDM
T-182	F-M	BK300
T-197	F-M	TC207
T-209	F-M	TC203-U
T-212	F-M	BK208
T-212FA	F-M	TC208-XJ
T-215	F-M	TC1345
T-220	F-M	BK228/9
T-230	F-M	TC231
T-240	F-M	TC241
T-240-C	F-M	TC242
T-340	F-M	TC1345
T-350	F-M	TC1350
T-370	F-M	TC1356
T-470	F-M	TC4470
T-472	F-M	TC1372-XJ
T1345R	MWT	BK1345
T1350R	MWT	BK1350
T1356R	MWT	BK1356
T1372R	MWT	BK1372
T172FGR	MWT	TC205-FDM
T172R	MWT	TC205-QDM
T203R	MWT	BK203Q
T207R	MWT	BK207
T20R	MWT	BK20
T212R	MWT	BK208
T229R	MWT	BK228/9X
T231R	MWT	BK231
T241R	MWT	BK241
T28F	MWT	BK28
TCRK-1345	DT	TC1345
TCRK-1350	DT	TC1350
TCRK-1354	DT	TC1354
TCRK-1356	DT	TC1356
TCRK-1372	DT	BK1372
TCRK-172	DT	TC205-QDM
TCRK172FG	DT	TC205-FDM
TCRK-203	DT	TC203-U
TCRK-207	DT	TC207

TCRK-208	DT	BK208
TCRK208FA	DT	TC208-XJ
TCRK-221	DT	BK221
TCRK-229	DT	TC228/9
TCRK-231	DT	TC231
TCRK-241	DT	TC241
TCRK-242	DT	TC242
TCRK-4404	DT	BK4405
TCRK-4470	DT	TC4470
TRK-161	DT	TC18
TRK-166A	DT	TC20
TRK-172	DT	TC205-QDM
TRK-172FG	DT	TC205-FDM
TRK-182	DT	BK300
TRK-209	DT	TC203-U
TRK-212	DT	BK208
TRK-212FA	DT	TC208-XJ
TSK1345	ATP	K100909
TSK1350	ATP	K100910
TSK1354	ATP	K100912
TSK1356	ATP	K100919
TSK1372	ATP	SK1372
TSK203F	ATP	SK203-F
TSK203G	ATP	K100900
TSK205CHEVY	ATP	K100901
TSK205COMBO	ATP	SK205-UDM
TSK205REMOTE	ATP	SK205
TSK207	ATP	K100907
TSK208	ATP	K100908
TSK229	ATP	K100908
TSK231	ATP	K100907
TSK241	ATP	K100908
TSK242	ATP	K100918

Ace is Ace-O-Matic, ATP is All Transmission Parts,
DT Is DT Components/North Coast Bearings, F-M is Federal Mogul,
MWT is Midwest Truck/Motive Gear, Perf is Perfection Hy-Test

Ball Bearings



Quality names produced to our specifications. Steel retainers are standard. All open and snap ring groove bearings are full face. No re-grooved product supplied. All single row angular contact bearings are a full 40 degree. All double row ball bearings are maximum capacity type with the correct angle of convergence or divergence for the application. Product to ABEC as well as ISO standards. No unmarked product. 100% OE approved - *MRC - SKF - NTN - Nachi*.

Cylindrical Roller Bearings



Only vehicle OE approved product. Bearings with the correct diametrical pitch diameter and radial clearances. Rollers and raceways crowned to insure maximum osculation and dynamic load distribution. No plastic retainer unless OE specified. RBEC specified material only. 100% U.S. made case carburized - *Link Belt - NTN Bower*.

Needle Bearings



All inch needle product U.S. made. Most metric sizes are German or Japanese for foreign vehicle. All needle product supplies is 100% OE approved. *INA - Torrington*.

Rod Ends



100% OE approved, U.S. made. Aviation/Military certifiable. *Aurora - National*

Tapered Roller Bearings



100% OE approved product. Tapered sets are 100% shimmed to avoid damage in shipment. Case carburized, AFBMA grade 7 product. *Timken - SKF - NTN - Bower*.

Oil Seals



100% OE Approved. Combine that with years of rebuilders knowledge means we know where to use flanged oil seals and what designs work the best! Most material U.S. made: NOK mostly for foreign applications or where they are single source at the OE level. *CR - National - NOK*

Gaskets



We obtain gaskets from OE Approved Cutters. Gaskets produced from U.S.A. made material, Armstrong N852, N8051 or our engineering approved equivalent. Proper thickness of gasket material is critical. So is compressibility, density and tensile strength. Compatibility with gear case lubricates is also examined to insure long, trouble free life. Our Gaskets work "*Full time - Every time!*"
No Asbestos content or other environmentally unfriendly materials used!

Misc. Materials



Only Permatex-Loctite material is used. Bronze synchronizer rings only. No Brass rings used. All snap rings are U.S. or Japanese made and meet SAE specifications. All O-Ring and rubber parts are U.S.A. made and to SAE specifications. All shim material is U.S. made to our engineering specifications and design. Extension housing bushings are Clevite. Other small parts made by Clevite U.S.A. and so marked, or are original. Felt seals are U.S. made to SAE specifications: F1, F5, F10, or F50. All bearing surface thrust washers are produced by needle bearing manufacturers to insure proper osculation. Spacer rings are ground to the proper thickness. All small parts are covered by our engineering specifications, and subject to our quality assurance program.

**Deviation from the above outlined bearing brands based
only on OE approved products**

All product clearly marked by the manufacturer and the country of origin.